

COMPLEMENTARY PAIR SMALL SIGNAL SURFACE MOUNT TRANSISTOR
Features

- Epitaxial Die Construction
- Two Internally Isolated NPN/PNP Transistors in one package
- Ultra-Small Surface Mount Package
- **Lead Free/RoHS Compliant (Note 2)**
- **Qualified to AEC-Q101 Standards for High Reliability**
- **"Green" Device (Notes 3 and 4)**

Mechanical Data

- Case: SOT-363
- Case Material: Molded Plastic, "Green" Molding Compound, Note 4. UL Flammability Classification Rating 94V-0
- Moisture Sensitivity: Level 1 per J-STD-020D
- Terminals: Matte Tin Finish annealed over Alloy 42 leadframe (Lead Free Plating) Solderable per MIL-STD-202, Method 208
- Terminal Connections: See Diagram
- Marking Information: See Page 4
- Ordering Information: See Page 4
- Weight: 0.006 grams (approximate)



Top View

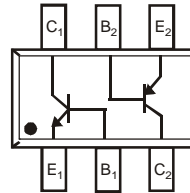

Device Schematic

Maximum Ratings, NPN Section @ $T_A = 25^\circ\text{C}$ unless otherwise specified

Characteristic	Symbol	Value	Unit
Collector-Base Voltage	V_{CBO}	50	V
Collector-Emitter Voltage	V_{CEO}	45	V
Emitter-Base Voltage	V_{EBO}	6.0	V
Collector Current	I_C	100	mA
Peak Collector Current	I_{CM}	200	mA
Peak Emitter Current	I_{EM}	200	mA

Maximum Ratings, PNP Section @ $T_A = 25^\circ\text{C}$ unless otherwise specified

Characteristic	Symbol	Value	Unit
Collector-Base Voltage	V_{CBO}	-50	V
Collector-Emitter Voltage	V_{CEO}	-45	V
Emitter-Base Voltage	V_{EBO}	-5.0	V
Collector Current	I_C	-100	mA
Peak Collector Current	I_{CM}	-200	mA
Peak Emitter Current	I_{EM}	-200	mA

Thermal Characteristics

Characteristic	Symbol	Value	Unit
Power Dissipation (Note 1) @ $T_A = 25^\circ\text{C}$ Total Device	P_D	200	mW
Thermal Resistance, Junction to Ambient (Note 1) @ $T_A = 25^\circ\text{C}$	$R_{\theta JA}$	625	$^\circ\text{C/W}$
Operating and Storage Temperature Range	T_J, T_{STG}	-65 to +150	$^\circ\text{C}$

- Notes:
1. Device mounted on FR-4 PCB, 1 inch x 0.85 inch x 0.062 inch; pad layout as shown on Diodes Inc. suggested pad layout document AP02001, which can be found on our website at <http://www.diodes.com/datasheets/ap02001.pdf>.
 2. No purposefully added lead.
 3. Diodes Inc.'s "Green" policy can be found on our website at http://www.diodes.com/products/lead_free/index.php.
 4. Product manufactured with Date Code UO (week 40, 2007) and newer are built with Green Molding Compound. Product manufactured prior to Date Code UO are built with Non-Green Molding Compound and may contain Halogens or Sb2O3 Fire Retardants

Electrical Characteristics, NPN Section @ $T_A = 25^\circ\text{C}$ unless otherwise specified

Characteristic	Symbol	Min	Typ	Max	Unit	Test Condition
Collector-Base Breakdown Voltage (Note 5)	$V_{(BR)CBO}$	50	—	—	V	$I_C = 10\mu\text{A}, I_B = 0$
Collector-Emitter Breakdown Voltage (Note 5)	$V_{(BR)CEO}$	45	—	—	V	$I_C = 10\text{mA}, I_B = 0$
Emitter-Base Breakdown Voltage (Note 5)	$V_{(BR)EBO}$	6	—	—	V	$I_E = 1\mu\text{A}, I_C = 0$
DC Current Gain (Note 5)	h_{FE}	200	290	450	—	$V_{CE} = 5.0\text{V}, I_C = 2.0\text{mA}$
Collector-Emitter Saturation Voltage (Note 5)	$V_{CE(SAT)}$	—	90 200	250 600	mV	$I_C = 10\text{mA}, I_B = 0.5\text{mA}$ $I_C = 100\text{mA}, I_B = 5.0\text{mA}$
Base-Emitter Saturation Voltage (Note 5)	$V_{BE(SAT)}$	—	700 900	—	mV	$I_C = 10\text{mA}, I_B = 0.5\text{mA}$ $I_C = 100\text{mA}, I_B = 5.0\text{mA}$
Base-Emitter Voltage (Note 5)	$V_{BE(ON)}$	580	660	700 720	mV	$V_{CE} = 5.0\text{V}, I_C = 2.0\text{mA}$ $V_{CE} = 5.0\text{V}, I_C = 10\text{mA}$
Collector-Cutoff Current (Note 5)	I_{CBO}	—	—	15	nA	$V_{CB} = 30\text{V}$
	I_{CBO}	—	—	5.0	μA	$V_{CB} = 30\text{V}, T_A = 150^\circ\text{C}$
Gain Bandwidth Product	f_T	100	300	—	MHz	$V_{CE} = 5.0\text{V}, I_C = 10\text{mA}, f = 100\text{MHz}$
Collector-Base Capacitance	C_{CBO}	—	3.5	6.0	pF	$V_{CB} = 10\text{V}, f = 1.0\text{MHz}$
Noise Figure	NF	—	2.0	10	dB	$V_{CE} = 5\text{V}, I_C = 200\mu\text{A}, R_G = 2.0\text{k}\Omega,$ $f = 1.0\text{kHz}, \Delta f = 200\text{Hz}$

Electrical Characteristics, PNP Section @ $T_A = 25^\circ\text{C}$ unless otherwise specified

Characteristic	Symbol	Min	Typ	Max	Unit	Test Condition
Collector-Base Breakdown Voltage (Note 5)	$V_{(BR)CBO}$	-50	—	—	V	$I_C = -10\mu\text{A}, I_B = 0$
Collector-Emitter Breakdown Voltage (Note 5)	$V_{(BR)CEO}$	-45	—	—	V	$I_C = -10\text{mA}, I_B = 0$
Emitter-Base Breakdown Voltage (Note 5)	$V_{(BR)EBO}$	-5	—	—	V	$I_E = -1\mu\text{A}, I_C = 0$
DC Current Gain (Note 5)	h_{FE}	220	290	475	—	$V_{CE} = -5.0\text{V}, I_C = -2.0\text{mA}$
Collector-Emitter Saturation Voltage (Note 5)	$V_{CE(SAT)}$	—	-75 -250	-300 -650	mV	$I_C = -10\text{mA}, I_B = -0.5\text{mA}$ $I_C = -100\text{mA}, I_B = -5.0\text{mA}$
Base-Emitter Saturation Voltage (Note 5)	$V_{BE(SAT)}$	—	-700 -850	—	mV	$I_C = -10\text{mA}, I_B = -0.5\text{mA}$ $I_C = -100\text{mA}, I_B = -5.0\text{mA}$
Base-Emitter Voltage (Note 5)	$V_{BE(ON)}$	-600	-650	-750 -820	mV	$V_{CE} = -5.0\text{V}, I_C = -2.0\text{mA}$ $V_{CE} = -5.0\text{V}, I_C = -10\text{mA}$
Collector-Cutoff Current (Note 5)	I_{CBO}	—	—	-15	nA	$V_{CB} = -30\text{V}$
	I_{CBO}	—	—	-4.0	μA	$V_{CB} = -30\text{V}, T_A = 150^\circ\text{C}$
Gain Bandwidth Product	f_T	100	200	—	MHz	$V_{CE} = -5.0\text{V}, I_C = -10\text{mA}, f = 100\text{MHz}$
Collector-Base Capacitance	C_{CBO}	—	3	4.5	pF	$V_{CB} = -10\text{V}, f = 1.0\text{MHz}$
Noise Figure	NF	—	—	10	dB	$V_{CE} = -5\text{V}, I_C = -200\mu\text{A}, R_G = 2.0\text{k}\Omega,$ $f = 1.0\text{kHz}, \Delta f = 200\text{Hz}$

Notes: 5. Short duration pulse test used to minimize self-heating effect.

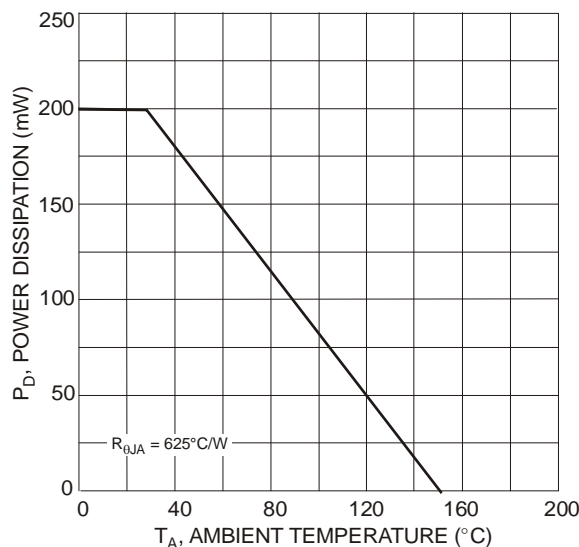

Fig. 1 Power Dissipation vs. Ambient Temperature (Total Device, Note 1)

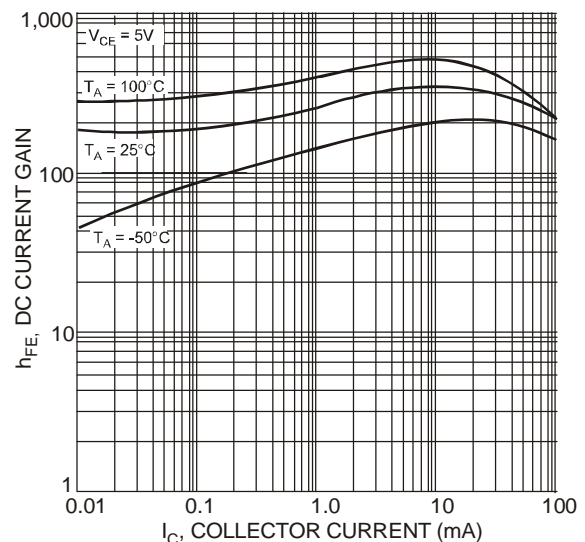

Fig. 2 Typical DC Current Gain vs. Collector Current (NPN)

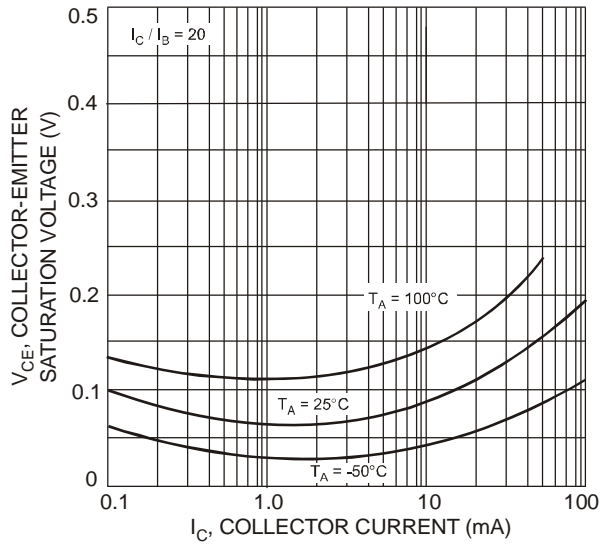

Fig. 3 Typical Collector-Emitter Saturation Voltage vs. Collector Current (NPN)

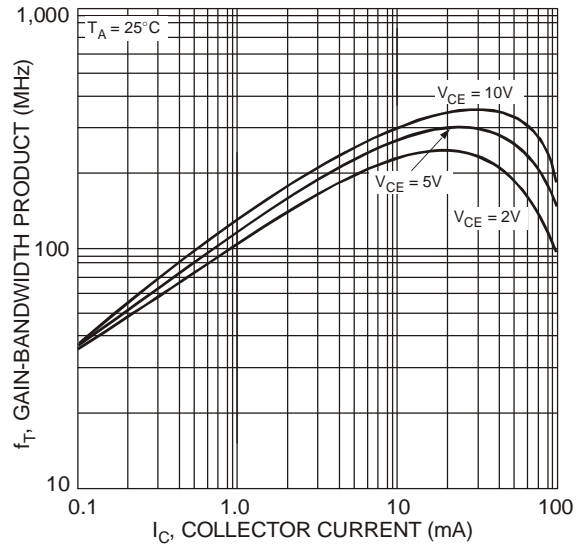

Fig. 4 Typical Gain-Bandwidth Product vs. Collector Current (NPN)

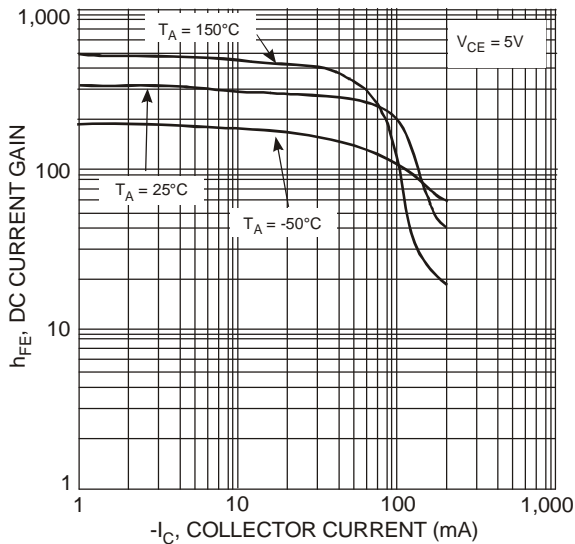

Fig. 5 Typical DC Current Gain vs. Collector Current (PNP)

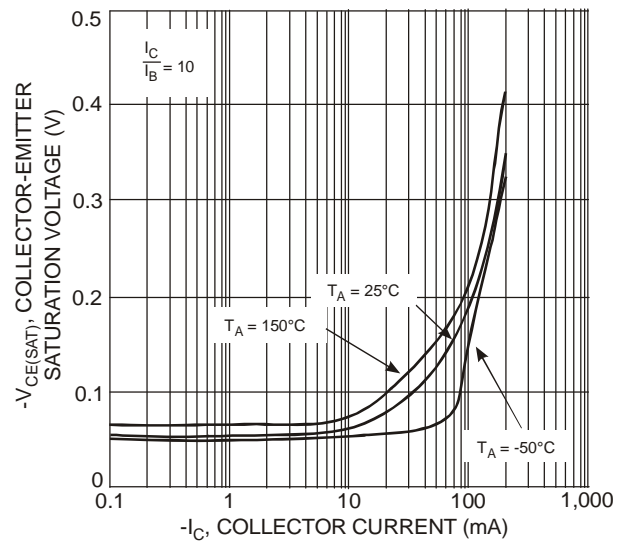

Fig. 6 Typical Collector-Emitter Saturation Voltage vs. Collector Current (PNP)

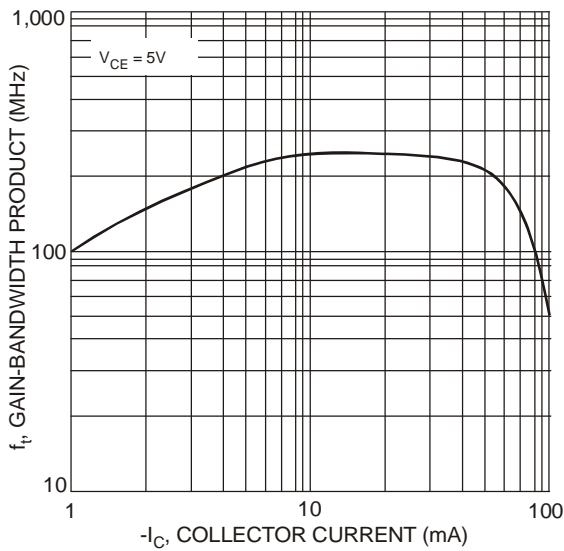
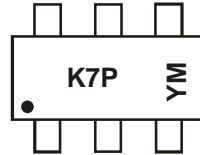

Fig. 7 Typical Gain-Bandwidth Product vs. Collector Current (PNP)

Ordering Information (Note 6)

Part Number	Case	Packaging
BC847PN-7-F	SOT-363	3000/Tape & Reel

Notes: 6. For packaging details, go to our website at <http://www.diodes.com/datasheets/ap02007.pdf>.

Marking Information

K7P = Product Type Marking Code
 YM = Date Code Marking
 Y = Year (ex: T = 2006)
 M = Month (ex: 9 = September)

Date Code Key

Year	2001	2002	2003	2004	2005	2006	2007	2008	2009	2010	2011	2012	2013	2014	2015
Code	M	N	P	R	S	T	U	V	W	X	Y	Z	A	B	C

Month	Jan	Feb	Mar	Apr	May	Jun	Jul	Aug	Sep	Oct	Nov	Dec
Code	1	2	3	4	5	6	7	8	9	O	N	D

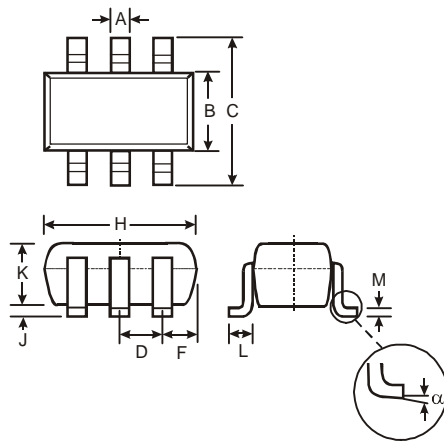
Package Outline Dimensions

SOT-363		
Dim	Min	Max
A	0.10	0.30
B	1.15	1.35
C	2.00	2.20
D	0.65 Typ	
F	0.40	0.45
H	1.80	2.20
J	0	0.10
K	0.90	1.00
L	0.25	0.40
M	0.10	0.22
α	0°	8°
All Dimensions in mm		

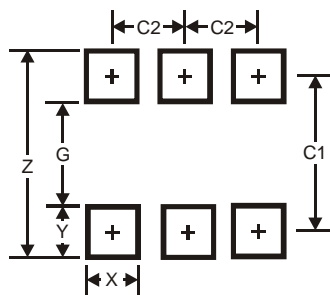
Suggested Pad Layout

Dimensions	Value (in mm)
Z	2.5
G	1.3
X	0.42
Y	0.6
C1	1.9
C2	0.65

IMPORTANT NOTICE

Diodes Incorporated and its subsidiaries reserve the right to make modifications, enhancements, improvements, corrections or other changes without further notice to any product herein. Diodes Incorporated does not assume any liability arising out of the application or use of any product described herein; neither does it convey any license under its patent rights, nor the rights of others. The user of products in such applications shall assume all risks of such use and will agree to hold Diodes Incorporated and all the companies whose products are represented on our website, harmless against all damages.

LIFE SUPPORT

Diodes Incorporated products are not authorized for use as critical components in life support devices or systems without the expressed written approval of the President of Diodes Incorporated.