

LME49724

*LME49724 High Performance, High Fidelity, Fully-Differential Audio
Operational Amplifier*



Literature Number: SNAS438

LME49724

High Performance, High Fidelity, Fully-Differential Audio Operational Amplifier

General Description

The LME49724 is an ultra-low distortion, low noise, high slew rate fully-differential operational amplifier optimized and fully specified for high performance, high fidelity applications. Combining advanced leading-edge process technology with state of the art circuit design, the LME49724 fully-differential audio operational amplifier delivers superior audio signal amplification for outstanding audio performance. The LME49724 combines extremely low voltage noise density ($2.1\text{nV}/\sqrt{\text{Hz}}$) with vanishingly low THD+N (0.00003%) to easily satisfy the most demanding audio applications. To ensure that the most challenging loads are driven without compromise, the LME49724 has a high slew rate of $\pm 18\text{V}/\mu\text{s}$ and an output current capability of $\pm 80\text{mA}$. Further, dynamic range is maximized by an output stage that drives 600Ω loads to $52\text{V}_{\text{P-P}}$ while operating on a $\pm 15\text{V}$ supply voltage.

The LME49724's outstanding CMRR (102dB), PSRR (125dB), and V_{OS} (0.2mV) results in excellent operational amplifier DC performance.

The LME49724 has a wide supply range of $\pm 2.5\text{V}$ to $\pm 18\text{V}$. Over this supply range the LME49724's input circuitry maintains excellent common-mode and power supply rejection, as well as maintaining its low input bias current. The LME49724 is unity gain stable. This Fully-Differential Audio Operational Amplifier achieves outstanding AC performance while driving complex loads with capacitive values as high as 100pF .

Key Specifications

■ Power Supply Voltage Range	$\pm 2.5\text{V}$ to $\pm 18\text{V}$
■ THD+N ($A_V = 1$, $V_{\text{OUT}} = 3V_{\text{RMS}}$, $f_{\text{IN}} = 1\text{kHz}$)	
$R_L = 2\text{k}\Omega$	0.00003% (typ)

$R_L = 600\Omega$	0.00003% (typ)
■ Input Noise Density	$2.1\text{nV}/\sqrt{\text{Hz}}$ (typ)
■ Slew Rate	$\pm 18\text{V}/\mu\text{s}$ (typ)
■ Gain Bandwidth Product	50MHz (typ)
■ Open Loop Gain ($R_L = 600\Omega$)	125dB (typ)
■ Input Bias Current	60nA (typ)
■ Input Offset Voltage	0.2mV (typ)
■ DC Gain Linearity Error	0.000009%

Features

- Drives 600Ω loads with full output signal swing
- Optimized for superior audio signal fidelity
- Output short circuit protection
- PSRR and CMRR exceed 100dB (typ)
- Available in PSOP package

Applications

- Ultra high quality audio amplification
- High fidelity preamplifiers and active filters
- Simple single-ended to differential conversion
- State of the art D-to-A converters
- State of the art A-to-D input amplifiers
- Professional Audio
- High fidelity equalization and crossover networks
- High performance line drivers and receivers

Typical Application

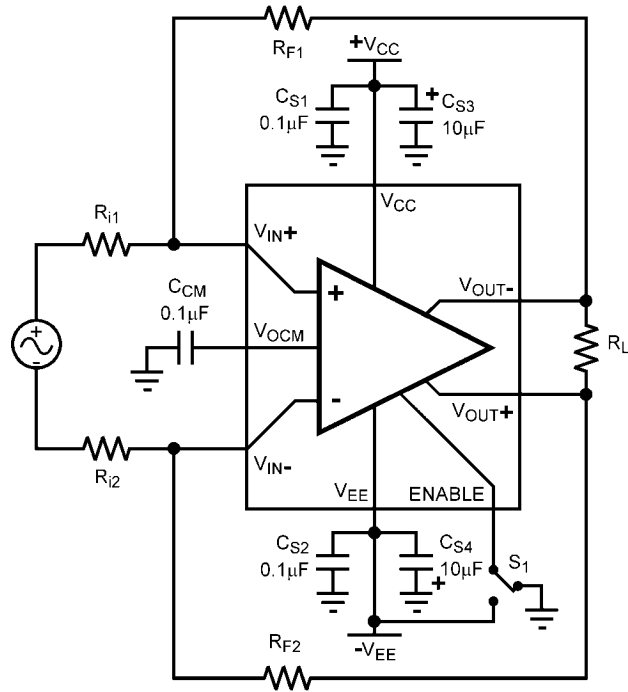

300442w9

FIGURE 1. Typical Application Circuit

Connection Diagrams

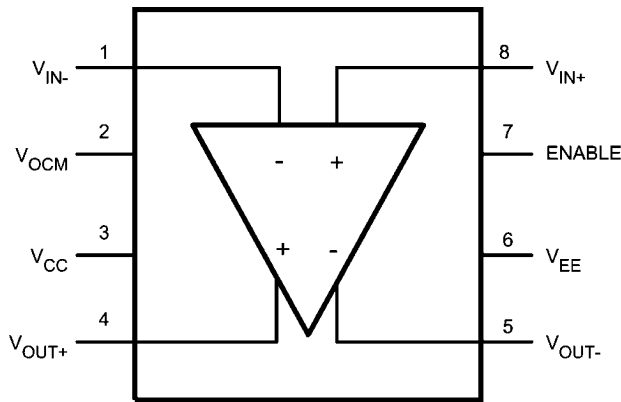

Order Number LME49724MR
See NS Package Number MRA08B

300442r4

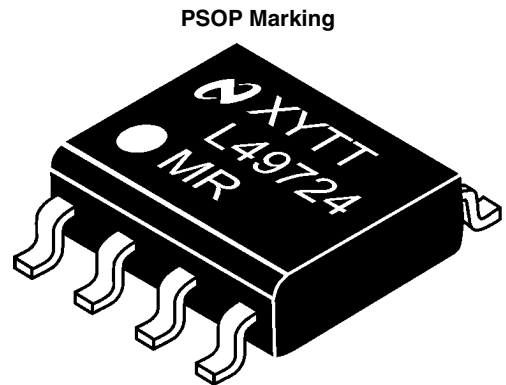

Top View
XY — Date Code
TT — Die Traceability
L49724 — LME49724
MR — Package Code

300442r6

Ordering Information

Order Number	Package	Package DWG #	Transport Media	MSL Level	Green Status	Features
LME49724MR	8 lead PSOP	MRA08B				

Pin Descriptions

Pin	Name	Pin Function	Type
1	V_{IN-}	Input pin	Analog Input
2	V_{OCM}	Sets the output DC voltage. Internally set by a resistor divider to the midpoint of the voltages on the V_{CC} and V_{EE} pins. Can be forced externally to a different voltage (50k Ω input impedance).	Analog Input
3	V_{CC}	Positive power supply pin.	Power Supply
4	V_{OUT+}	Output pin. Signal is inverted relative to V_{IN-} where the feedback loop is connected.	Analog Output
5	V_{OUT-}	Output pin. Signal is inverted relative to V_{IN+} where the feedback loop is connected.	Analog Output
6	V_{EE}	Negative power supply pin or ground for a single supply configuration.	Power Supply
7	ENABLE	Enables the LME49724 when the voltage is greater than 2.35V above the voltage on the V_{EE} pin. Disable the LME49724 by connecting to the same voltage as on the V_{EE} pin which will reduce current consumption to less than 0.3mA (typ).	Analog Input
8	V_{IN+}	Input pin	Analog Input
Exposed Pad		Exposed pad for improved thermal performance. Connect to the same potential as the V_{EE} pin or electrically isolate.	

Absolute Maximum Ratings (Notes 1, 2)

If Military/Aerospace specified devices are required, please contact the National Semiconductor Sales Office/ Distributors for availability and specifications.

Power Supply Voltage ($V_S = V_{CC} + IV_{EE}$)	38V
Storage Temperature	-65°C to 150°C
Input Voltage (V_{EE}) - 0.7V to (V_{CC}) + 0.7V	
Output Short Circuit	Continuous
Power Dissipation (Note 3)	Internally Limited
ESD Rating (Note 4)	2000V
ESD Rating (Note 5)	200V

Junction Temperature (T_{JMAX})	150°C
Soldering Information	
Vapor Phase (60sec.)	215°C
Infrared (60sec.)	220°C
Thermal Resistance θ_{JA} (MR)	49.6°C/W

Operating Ratings (Notes 1, 2)

Temperature Range $T_{MIN} \leq T_A \leq T_{MAX}$	-40°C \leq T_A \leq +85°C
Supply Voltage Range	$\pm 2.5V \leq V_S \leq \pm 18V$

Electrical Characteristics (Notes 1, 2) The following specifications apply for $V_S = \pm 15V$, $R_L = 2k\Omega$, $f_{IN} = 1kHz$, and $T_A = 25^\circ C$, unless otherwise specified.

Symbol	Parameter	Conditions	LME49724		Units (Limits)
			Typical	Limit	
			(Note 6)	(Note 7)	
POWER SUPPLY					
V_S	Operating Power Supply			$\pm 2.5V$ $\pm 18V$	V (min) V (max)
I_{CCQ}	Total Quiescent Current	$V_O = 0V$, $I_O = 0mA$ Enable = GND Enable = V_{EE}	10 0.3	15 0.5	mA (max) mA (max)
PSRR	Power Supply Rejection Ratio	$V_S = \pm 5V$ to $\pm 15V$ (Note 8)	125	95	dB (min)
V_{ENIH}	Enable High Input Voltage	Device active, $T_A = 25^\circ C$ (Note 9)	$V_{EE} + 2.35$		V
V_{ENIL}	Enable Low Input Voltage	Device disabled, $T_A = 25^\circ C$ (Note 9)	$V_{EE} + 1.75$		V
DYNAMIC PERFORMANCE					
THD+N	Total Harmonic Distortion + Noise	$A_V = 1$, $V_{OUT} = 3V_{RMS}$ $R_L = 2k\Omega$ $R_L = 600\Omega$	0.00003 0.00003	0.00009	% % (max)
IMD	Intermodulation Distortion	$A_V = 1$, $V_{OUT} = 3V_{RMS}$ Two-tone, 60Hz & 7kHz 4:1	0.0005		%
GBWP	Gain Bandwidth Product		50	35	MHz (min)
FPBW	Full Power Bandwidth	$V_{OUT} = 1V_{P-P}$, -3dB referenced to output magnitude at $f = 1kHz$	13		MHz
SR	Slew Rate	$R_L = 2k\Omega$	± 18	± 13	V/ μs (min)
t_S	Settling time	$A_V = -1$, 10V step, $C_L = 100pF$ settling time to 0.1%	0.2		μs
A_{VOL}	Open-Loop Voltage Gain	$-10V < V_{OUT} < 10V$, $R_L = 600\Omega$	125	100	dB (min)
		$-10V < V_{OUT} < 10V$, $R_L = 2k\Omega$	125		dB
		$-10V < V_{OUT} < 10V$, $R_L = 10k\Omega$	125		dB
NOISE					
e_N	Equivalent Input Noise Voltage	$f_{BW} = 20Hz$ to 20kHz	0.30	0.64	μV_{RMS} (max)
	Equivalent Input Noise Density	$f = 1kHz$ $f = 10Hz$	2.1 3.7		nV/ \sqrt{Hz} (max)
INPUT CHARACTERISTICS					
V_{OS}	Offset Voltage		± 0.2	± 1	mV (max)
$\Delta V_{OS}/\Delta Temp$	Average Input Offset Voltage Drift vs Temperature	$-40^\circ C \leq T_A \leq 85^\circ C$	0.5		$\mu V/^\circ C$

Symbol	Parameter	Conditions	LME49724		Units (Limits)
			Typical	Limit	
			(Note 6)	(Note 7)	
I_B	Input Bias Current	$V_{CM} = 0V$	60	200	nA (max)
I_{OS}	Input Offset Current	$V_{CM} = 0V$	10	65	nA (max)
$\Delta I_{OS}/\Delta Temp$	Input Bias Current Drift vs Temperature	$-40^\circ C \leq T_A \leq 85^\circ C$	0.1		nA/°C
V_{IN-CM}	Common-Mode Input Voltage Range		± 14	$V_{CC} - 1.5$ $V_{EE} + 1.5$	V (min) V (min)
CMRR	Common-Mode Rejection	$-10V < V_{CM} < 10V$	102	95	dB (min)
Z_{IN}	Differential Input Impedance		16		k Ω
	Common-Mode Input Impedance	$-10V < V_{CM} < 10V$	500		M Ω
OUTPUT CHARACTERISTICS					
V_{OUTMAX}	Maximum Output Voltage Swing	$R_L = 600\Omega$	52	50	V_{P-P} (min)
		$R_L = 2k\Omega$	52		V_{P-P}
		$R_L = 10k\Omega$	53		V_{P-P}
I_{OUT-CC}	Instantaneous Short Circuit Current		80		mA
R_{OUT}	Output Impedance	$f_{IN} = 10kHz$ Closed-Loop	0.01		Ω
		Open-Loop	23		Ω
C_{LOAD}	Capacitive Load Drive Overshoot	$C_L = 100pF$	5		%

Note 1: *Absolute Maximum Ratings* indicate limits beyond which damage to the device may occur, including inoperability and degradation of device reliability and/or performance. Functional operation of the device and/or non-degradation at the *Absolute Maximum Ratings* or other conditions beyond those indicated in the *Recommended Operating Conditions* is not implied. The *Recommended Operating Conditions* indicate conditions at which the device is functional and the device should not be operated beyond such conditions. All voltages are measured with respect to the ground pin, unless otherwise specified.

Note 2: The *Electrical Characteristics* tables list guaranteed specifications under the listed *Recommended Operating Conditions* except as otherwise modified or specified by the *Electrical Characteristics Conditions* and/or Notes. Typical specifications are estimations only and are not guaranteed.

Note 3: The maximum power dissipation must be derated at elevated temperatures and is dictated by T_{JMAX} , θ_{JA} , and the ambient temperature, T_A . The maximum allowable power dissipation is $P_{DMAX} = (T_{JMAX} - T_A) / \theta_{JA}$ or the number given in *Absolute Maximum Ratings*, whichever is lower.

Note 4: Human body model, applicable std. JESD22-A114C.

Note 5: Machine model, applicable std. JESD22-A115-A.

Note 6: Typical values represent most likely parametric norms at $T_A = +25^\circ C$, and at the *Recommended Operation Conditions* at the time of product characterization and are not guaranteed.

Note 7: Datasheet min/max specification limits are guaranteed by test or statistical analysis.

Note 8: PSRR is measured as follows: V_{OS} is measured at two supply voltages, $\pm 5V$ and $\pm 15V$. $PSRR = |20 \log(\Delta V_{OS}/\Delta V_S)|$.

Note 9: The ENABLE threshold voltage is determined by V_{BE} voltages and will therefore vary with temperature. The typical values represent the most likely parametric norms at $T_A = +25^\circ C$.

Typical Performance Characteristics

THD+N vs Frequency
 $V_S = \pm 2.5V, V_O = 0.5V_{RMS}$, Differential Input
 $R_L = 600\Omega, 2k\Omega, 10k\Omega, 80kHz BW$

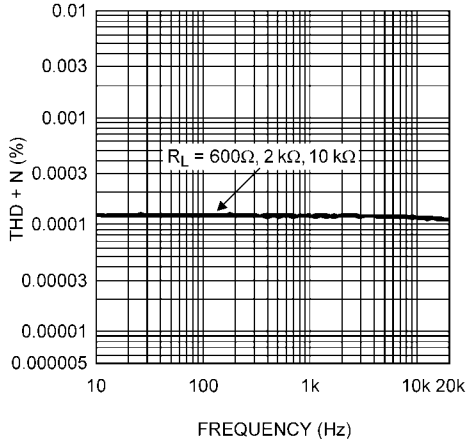

300442s3

THD+N vs Frequency
 $V_S = \pm 2.5V, V_O = 0.8V_{RMS}$, Differential Input
 $R_L = 600\Omega, 2k\Omega, 10k\Omega, 80kHz BW$

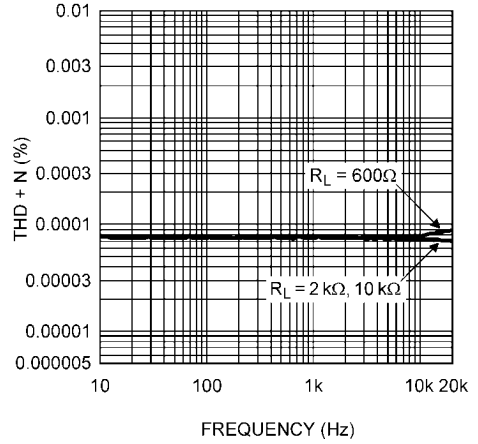

300442s4

THD+N vs Frequency
 $V_S = \pm 15V, V_O = 3V_{RMS}$, Differential Input
 $R_L = 600\Omega, 2k\Omega, 10k\Omega, 80kHz BW$

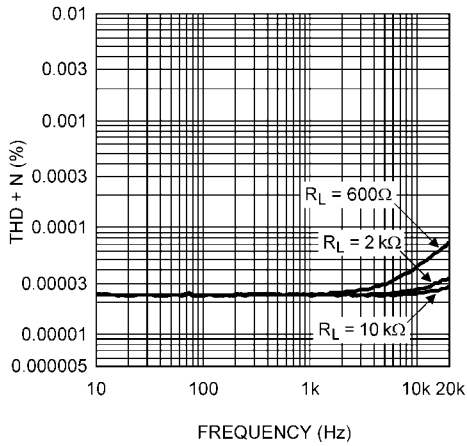

300442s5

THD+N vs Frequency
 $V_S = \pm 15V, V_O = 10V_{RMS}$, Differential Input
 $R_L = 600\Omega, 2k\Omega, 10k\Omega, 80kHz BW$

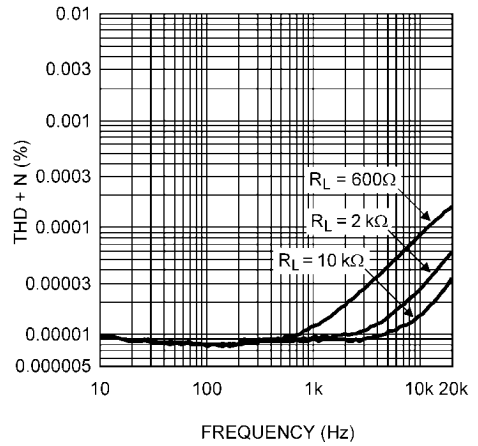

300442s6

THD+N vs Frequency
 $V_S = \pm 18V, V_O = 3V_{RMS}$, Differential Input
 $R_L = 600\Omega, 2k\Omega, 10k\Omega, 80kHz BW$

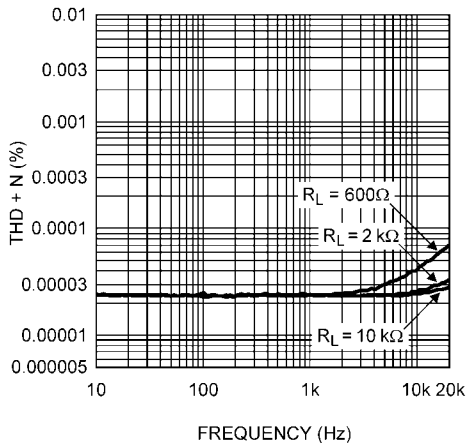

300442s7

THD+N vs Frequency
 $V_S = \pm 18V, V_O = 10V_{RMS}$, Differential Input
 $R_L = 600\Omega, 2k\Omega, 10k\Omega, 80kHz BW$

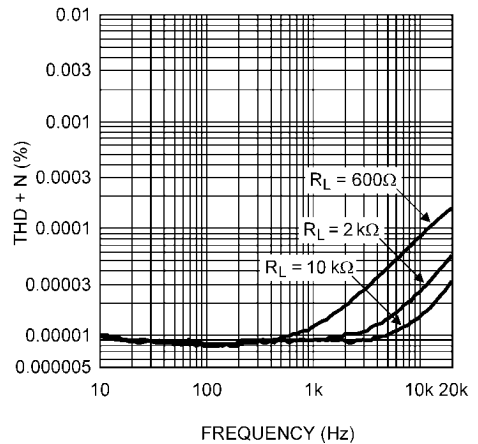

300442s8

THD+N vs Output Voltage
 $V_S = \pm 2.5V$, $R_L = 600\Omega$, Differential Input
 $f = 20\text{Hz}$, 1kHz , 20kHz , 80kHz BW

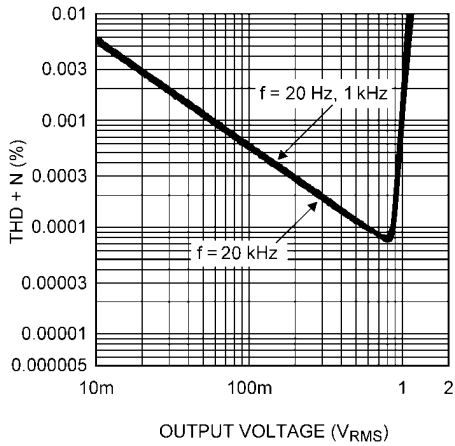

30044211

THD+N vs Output Voltage
 $V_S = \pm 15V$, $R_L = 600\Omega$, Differential Input
 $f = 20\text{Hz}$, 1kHz , 20kHz , 80kHz BW

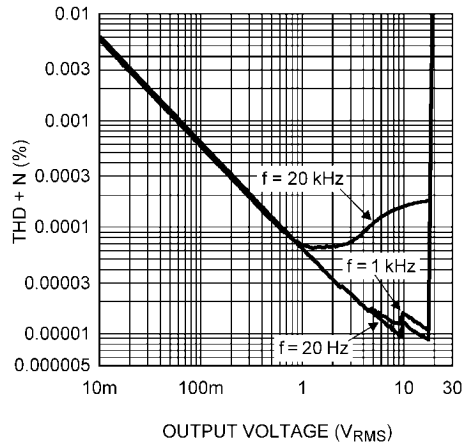

30044214

THD+N vs Output Voltage
 $V_S = \pm 18V$, $R_L = 600\Omega$, Differential Input
 $f = 20\text{Hz}$, 1kHz , 20kHz , 80kHz BW

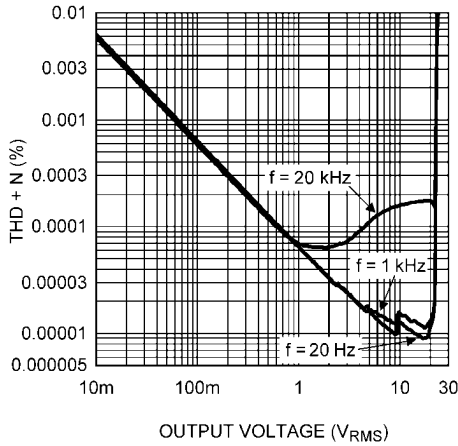

30044217

THD+N vs Output Voltage
 $V_S = \pm 2.5V$, $R_L = 2k\Omega$, Differential Input
 $f = 20\text{Hz}$, 1kHz , 20kHz , 80kHz BW

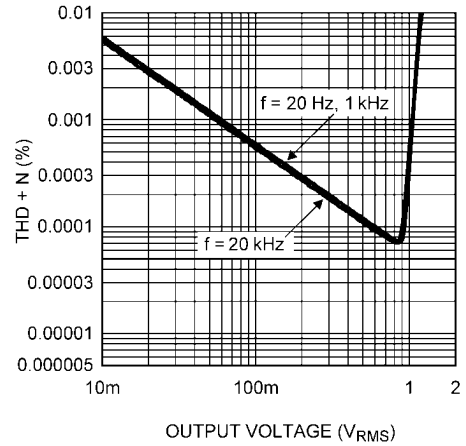

300442s9

THD+N vs Output Voltage
 $V_S = \pm 15V$, $R_L = 2k\Omega$, Differential Input
 $f = 20\text{Hz}$, 1kHz , 20kHz , 80kHz BW

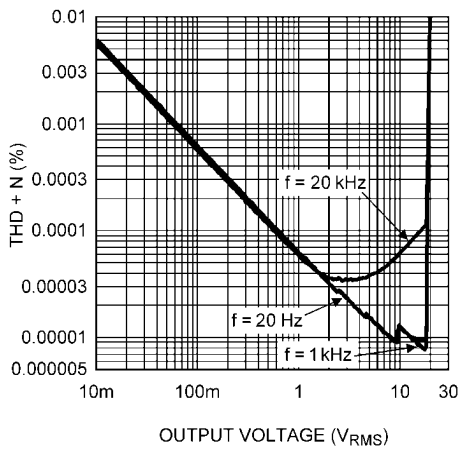

30044212

THD+N vs Output Voltage
 $V_S = \pm 18V$, $R_L = 2k\Omega$, Differential Input
 $f = 20\text{Hz}$, 1kHz , 20kHz , 80kHz BW

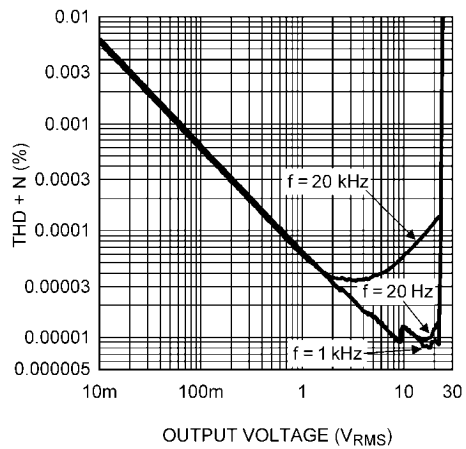

30044215

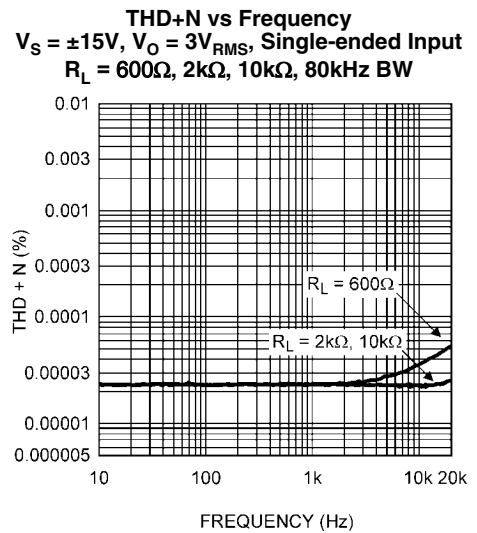
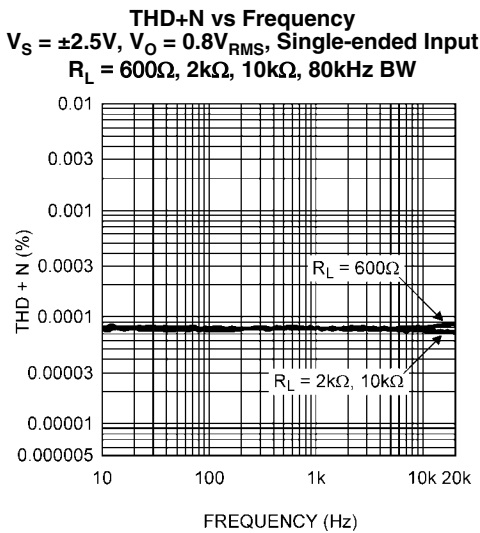
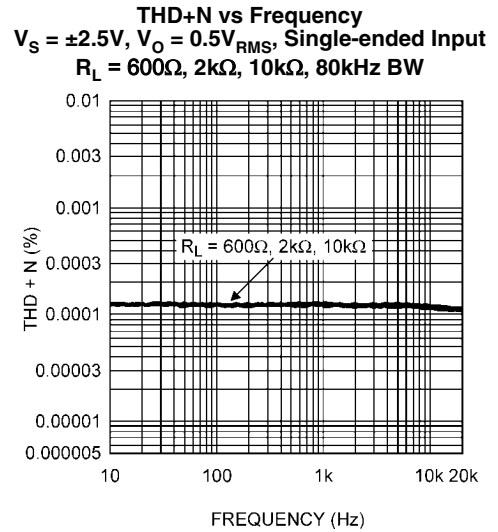
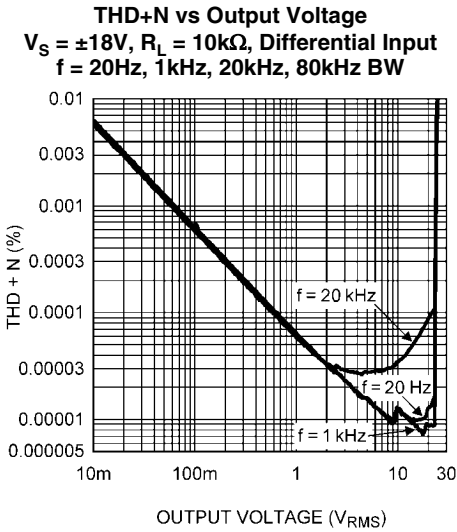
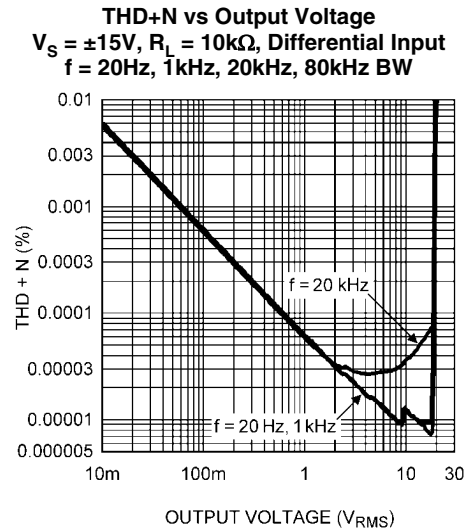
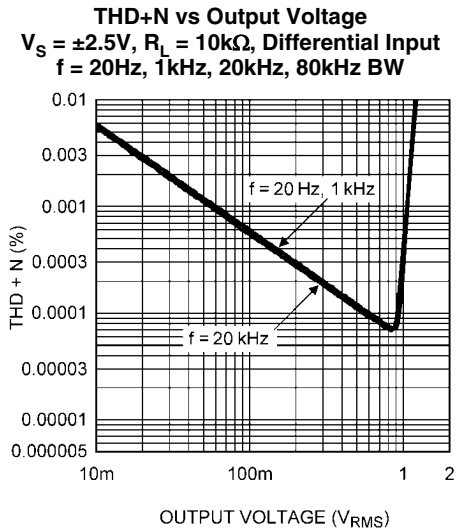

THD+N vs Frequency
 $V_S = \pm 15V, V_O = 5V_{RMS}$, Single-ended Input
 $R_L = 600\Omega, 2k\Omega, 10k\Omega, 80kHz$ BW

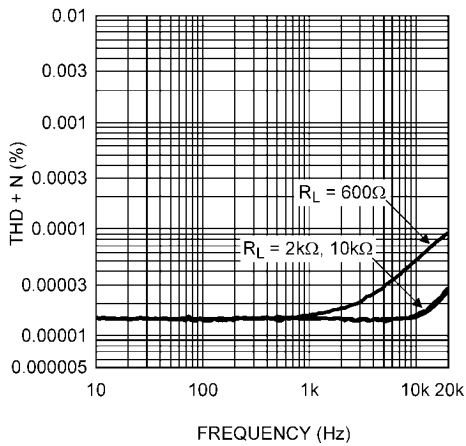

300442v1

THD+N vs Frequency
 $V_S = \pm 18V, V_O = 3V_{RMS}$, Single-ended Input
 $R_L = 600\Omega, 2k\Omega, 10k\Omega, 80kHz$ BW

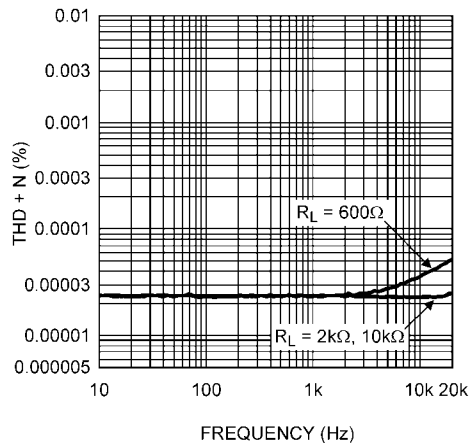

300442v2

THD+N vs Frequency
 $V_S = \pm 18V, V_O = 5V_{RMS}$, Single-ended Input
 $R_L = 600\Omega, 2k\Omega, 10k\Omega, 80kHz$ BW

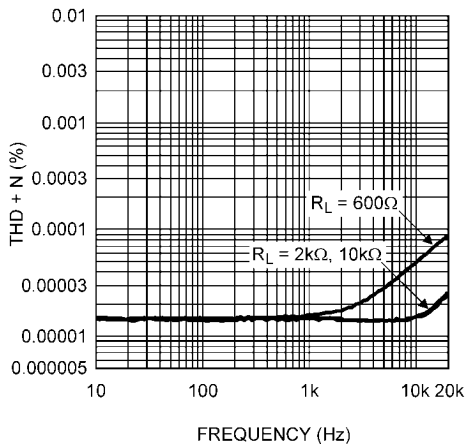

300442v3

THD+N vs Output Voltage
 $V_S = \pm 2.5V, R_L = 600\Omega$, Single-ended Input
 $f = 20Hz, 1kHz, 20kHz, 80kHz$ BW

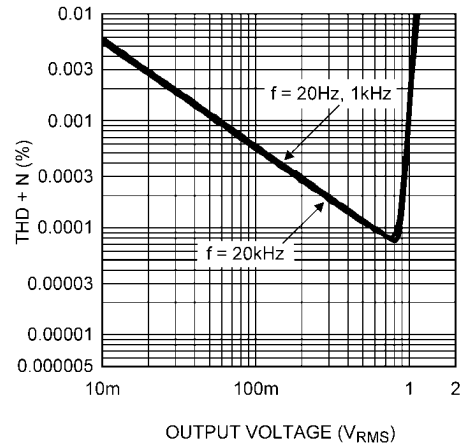

300442v6

THD+N vs Output Voltage
 $V_S = \pm 15V, R_L = 600\Omega$, Single-ended Input
 $f = 20Hz, 1kHz, 20kHz, 80kHz$ BW

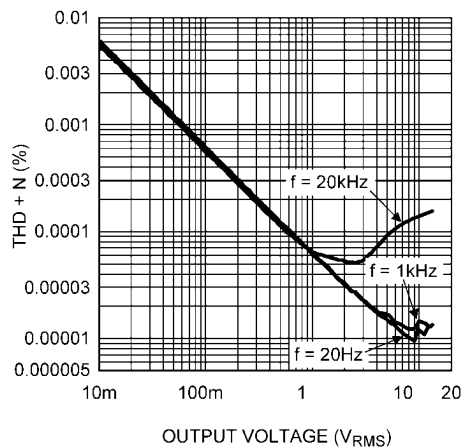

300442v9

THD+N vs Output Voltage
 $V_S = \pm 18V, R_L = 600\Omega$, Single-ended Input
 $f = 20Hz, 1kHz, 20kHz, 80kHz$ BW

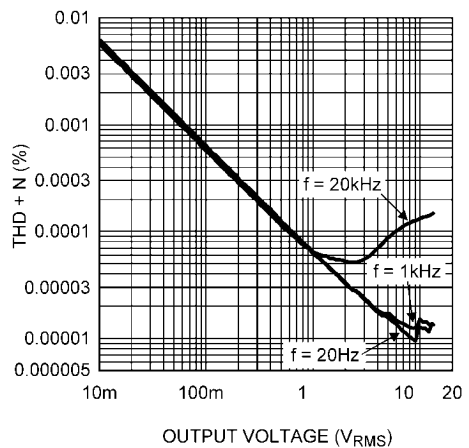

300442w2

THD+N vs Output Voltage
 $V_S = \pm 2.5V$, $R_L = 2k\Omega$, Single-ended Input
 $f = 20Hz, 1kHz, 20kHz, 80kHz$ BW

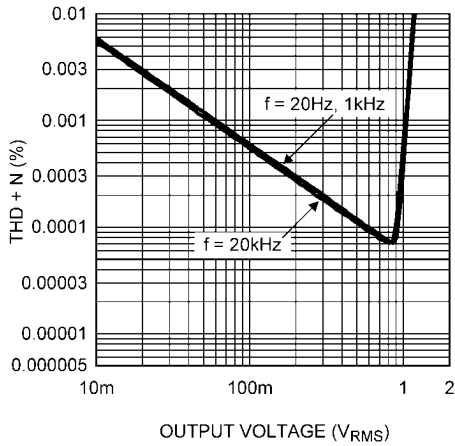

300442v4

THD+N vs Output Voltage
 $V_S = \pm 15V$, $R_L = 2k\Omega$, Single-ended Input
 $f = 20Hz, 1kHz, 20kHz, 80kHz$ BW

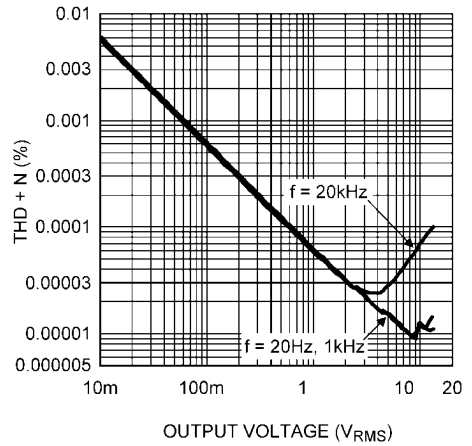

300442v7

THD+N vs Output Voltage
 $V_S = \pm 18V$, $R_L = 2k\Omega$, Single-ended Input
 $f = 20Hz, 1kHz, 20kHz, 80kHz$ BW

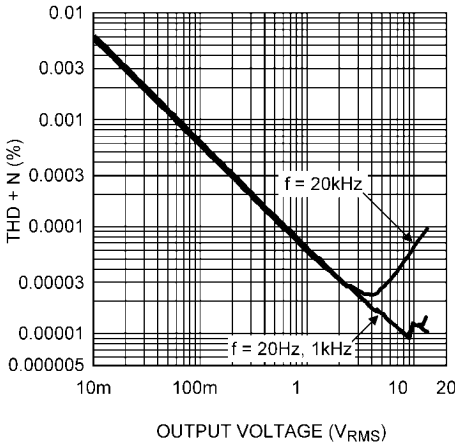

300442w0

THD+N vs Output Voltage
 $V_S = \pm 2.5V$, $R_L = 10k\Omega$, Single-ended Input
 $f = 20Hz, 1kHz, 20kHz, 80kHz$ BW

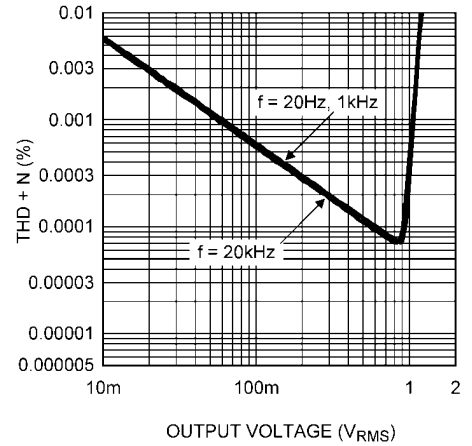

300442v5

THD+N vs Output Voltage
 $V_S = \pm 15V$, $R_L = 10k\Omega$, Single-ended Input
 $f = 20Hz, 1kHz, 20kHz, 80kHz$ BW

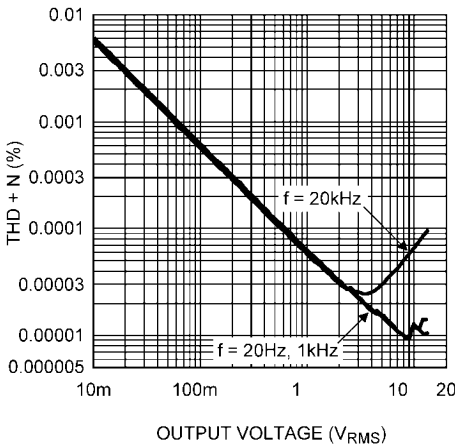

300442v8

THD+N vs Output Voltage
 $V_S = \pm 18V$, $R_L = 10k\Omega$, Single-ended Input
 $f = 20Hz, 1kHz, 20kHz, 80kHz$ BW

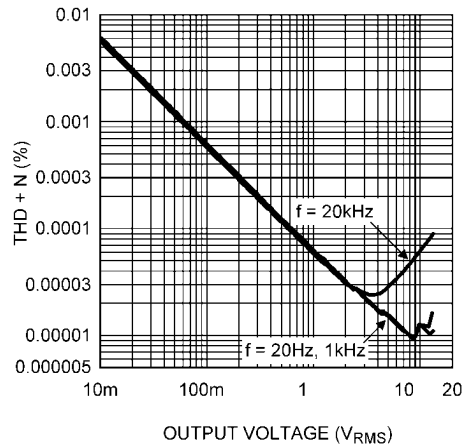

300442w1

PSRR vs Frequency
 $V_S = \pm 2.5V$, $R_L = 600\Omega$, Inputs to GND
 $V_{RIPPLE} = 200mV_{p,p}$, 80kHz BW

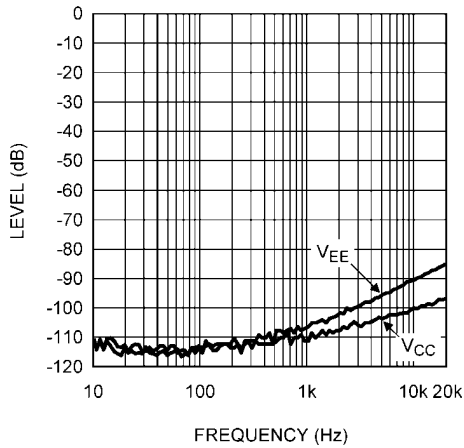

300442u0

PSRR vs Frequency
 $V_S = \pm 15V$, $R_L = 600\Omega$, Inputs to GND
 $V_{RIPPLE} = 200mV_{p,p}$, 80kHz BW

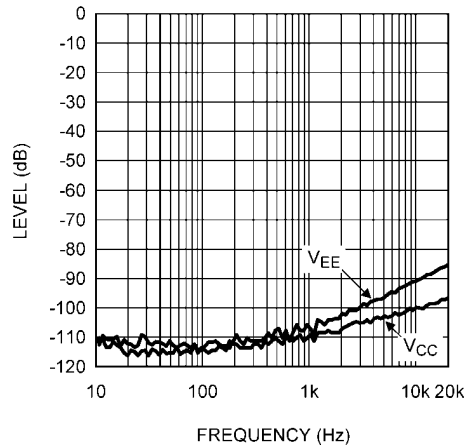

300442u3

PSRR vs Frequency
 $V_S = \pm 18V$, $R_L = 600\Omega$, Inputs to GND
 $V_{RIPPLE} = 200mV_{p,p}$, 80kHz BW

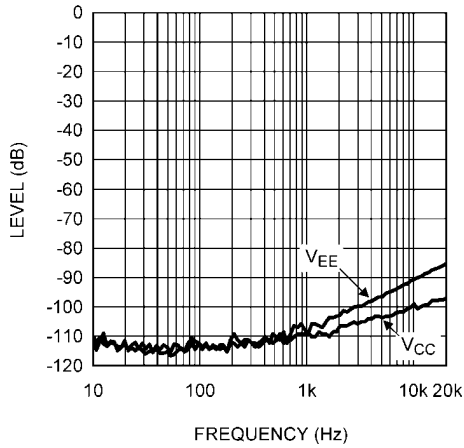

300442u6

PSRR vs Frequency
 $V_S = \pm 2.5V$, $R_L = 2k\Omega$, Inputs to GND
 $V_{RIPPLE} = 200mV_{p,p}$, 80kHz BW

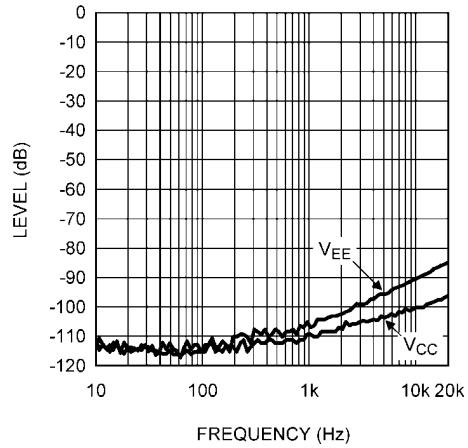

300442i8

PSRR vs Frequency
 $V_S = \pm 15V$, $R_L = 2k\Omega$, Inputs to GND
 $V_{RIPPLE} = 200mV_{p,p}$, 80kHz BW

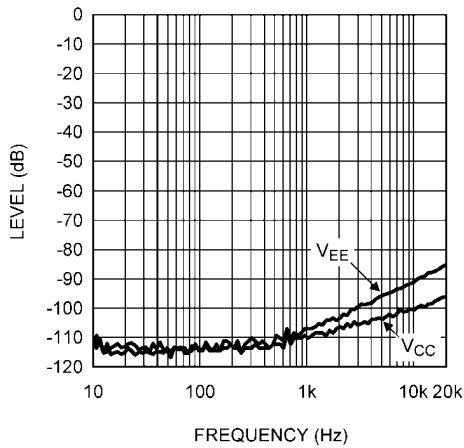

300442u1

PSRR vs Frequency
 $V_S = \pm 18V$, $R_L = 2k\Omega$, Inputs to GND
 $V_{RIPPLE} = 200mV_{p,p}$, 80kHz BW

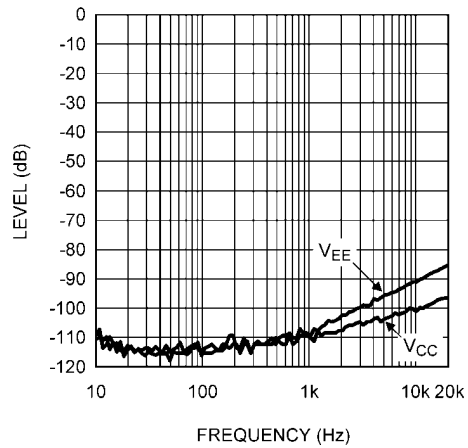

300442u4

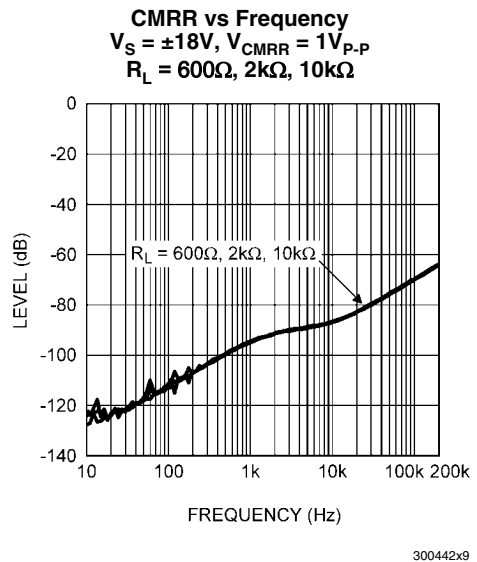
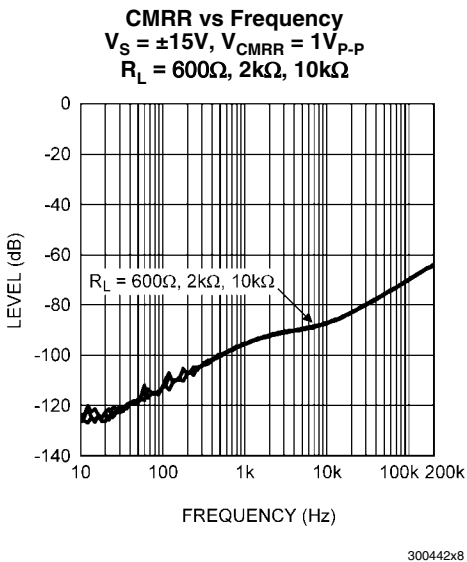
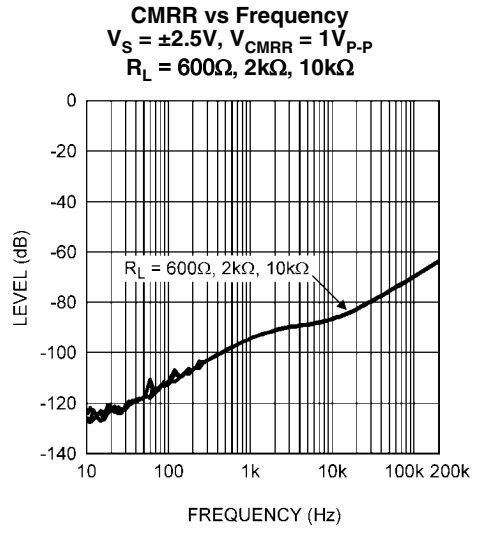
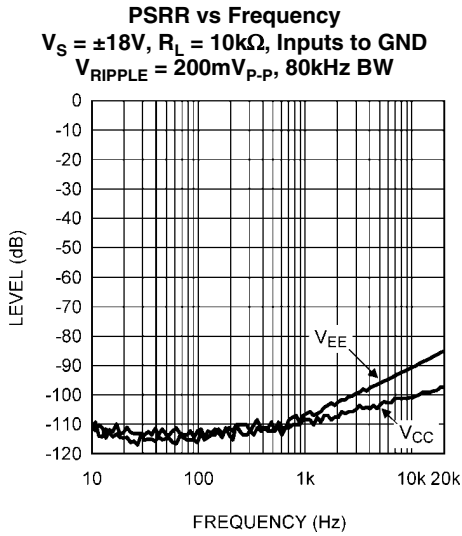
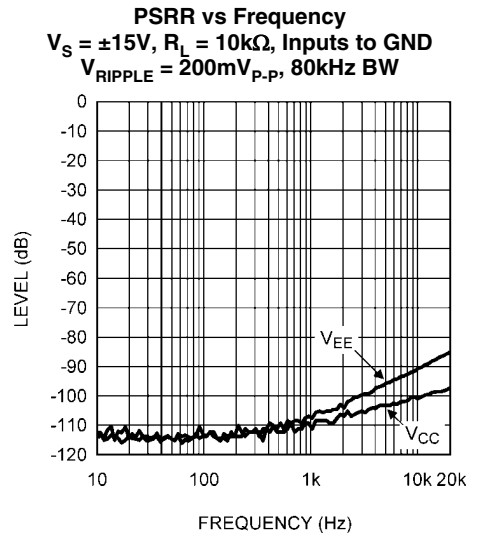
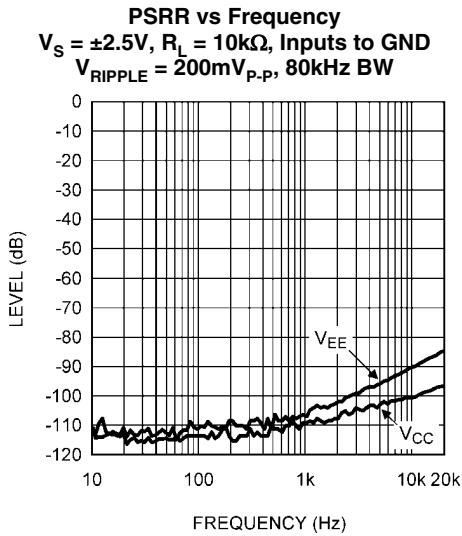

Output Voltage vs Load Resistance

$V_S = \pm 2.5V$, $R_L = 500\Omega - 10k\Omega$
 $THD+N \leq 1\%$, 80kHz BW

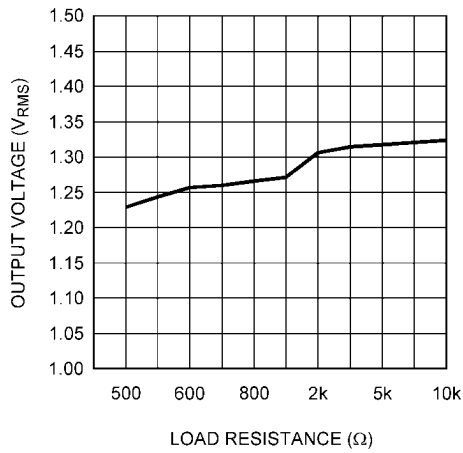

300442w3

Output Voltage vs Load Resistance

$V_S = \pm 15V$, $R_L = 500\Omega - 10k\Omega$
 $THD+N \leq 1\%$, 80kHz BW

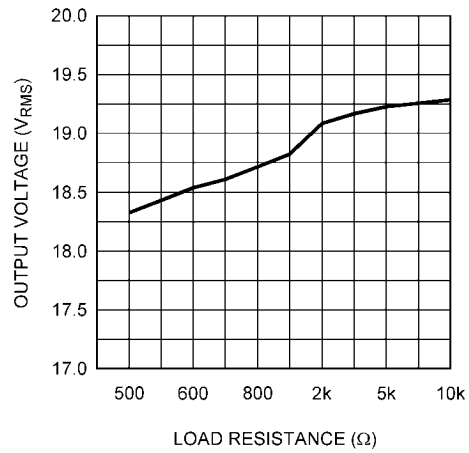

300442w4

Output Voltage vs Load Resistance

$V_S = \pm 18V$, $R_L = 500\Omega - 10k\Omega$
 $THD+N \leq 1\%$, 80kHz BW

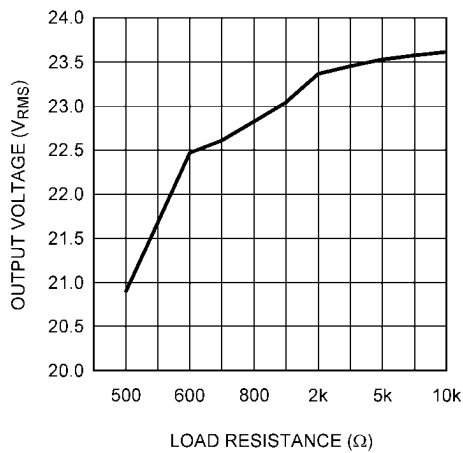

300442w5

Output Voltage vs Supply Voltage

$R_L = 600\Omega, 2k\Omega, 10k\Omega$, $THD+N \leq 1\%$
 80kHz BW

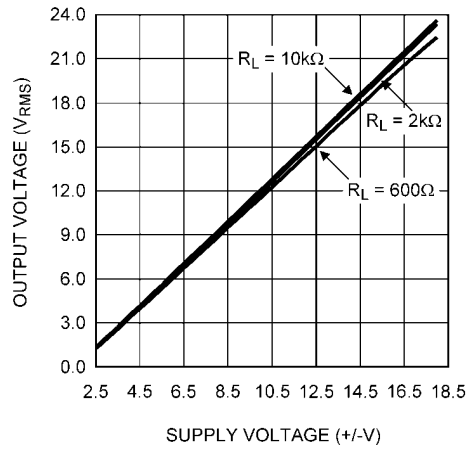

300442w6

Supply Current vs Supply Voltage

$V_{IN} = 0V$, $R_L = \text{No Load}$

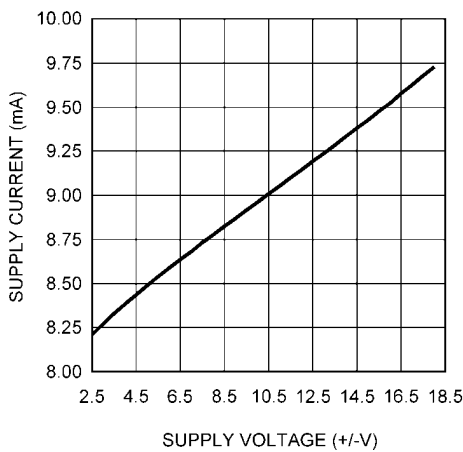

300442u7

Application Information

GENERAL OPERATION

The LME49724 is a fully differential amplifier with an integrated common-mode reference input (V_{OCM}). Fully differential amplification provides increased noise immunity, high dynamic range, and reduced harmonic distortion products.

Differential amplifiers typically have high CMRR providing improved immunity from noise. When input, output, and supply line trace pairs are routed together, noise pick up is common and easily rejected by the LME49724. CMRR performance is directly proportional to the tolerance and matching of the gain configuring resistors. With 0.1% tolerance resistors the worst case CMRR performance will be about 60dB (20LOG (0.001)).

A differential output has a higher dynamic range than a single-ended output because of the doubling of output voltage. The dynamic range is increased by 6dB as a result of the outputs being equal in magnitude but opposite in phase. As an example, a single-ended output with a $1V_{PP}$ signal will be two $1V_{PP}$ signals with a differential output. The increase is 20LOG (2) = 6dB. Differential amplifiers are ideal for low voltage applications because of the increase in signal amplitude relative to a single-ended amplifier and the resulting improvement in SNR.

Differential amplifiers can also have reduced even order harmonics, all conditions equal, when compared to a single-ended amplifier. The differential output causes even harmonics to cancel between the two inverted outputs leaving only the odd harmonics. In practice even harmonics do not cancel completely, however there still is a reduction in total harmonic distortion.

OUTPUT COMMON-MODE VOLTAGE (V_{OCM} pin)

The output common-mode voltage is the DC voltage on each output. The output common-mode voltage is set by the V_{OCM} pin. The V_{OCM} pin can be driven by a low impedance source. If no voltage is applied to the V_{OCM} pin, the DC common-mode output voltage will be set by the internal resistor divider to the midpoint of the voltages on the V_{CC} and V_{EE} pins. The input impedance of the V_{OCM} pin is 50k Ω . The V_{OCM} pin can be driven up to $V_{CC} - 1.5V$ and $V_{EE} + 1.5V$. The V_{OCM} pin should be bypassed to ground with a 0.1 μF to 1 μF capacitor. The V_{OCM} pin should be connected to ground when the desired output common-mode voltage is ground reference. The value of the external capacitor has an effect on the PSRR performance of the LME49724. With the V_{OCM} pin only bypassed with a low value capacitor, the PSRR performance of the LME49724 will be reduced, especially at low audio frequencies. For best PSRR performance, the V_{OCM} pin should be connected to stable, clean reference. Increasing the value of the bypass capacitor on the V_{OCM} pin will also improve PSRR performance.

ENABLE FUNCTION

The LME49724 can be placed into standby mode to reduce system current consumption by driving the ENABLE pin below $V_{EE} + 1.75V$. The LME49724 is active when the voltage on the ENABLE pin is above $V_{EE} + 2.35V$. The ENABLE pin should not be left floating. For best performance under all conditions, drive the ENABLE pin to the V_{EE} pin voltage to enter standby mode and to ground for active operation when operating from split supplies. When operating from a single

supply, drive the ENABLE pin to ground for standby mode and to V_{CC} for active mode.

FULLY DIFFERENTIAL OPERATION

The LME49724 performs best in a fully differential configuration. The circuit shown in Figure 2 is the typical fully differential configuration.

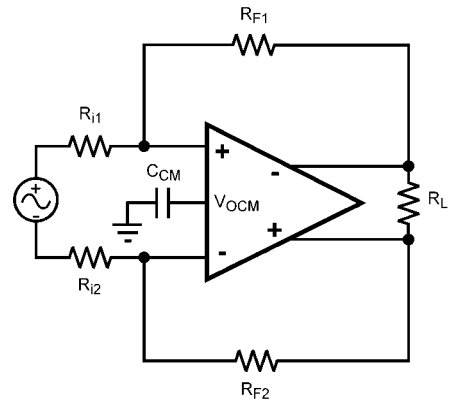

300442r9

FIGURE 2. Fully Differential Configuration

The closed-loop gain is shown in Equation 1 below.

$$A_V = R_F / R_i \quad (V/V) \quad (1)$$

Where $R_{F1} = R_{F2}$, $R_{i1} = R_{i2}$. Using low value resistors will give the lowest noise performance.

SINGLE-ENDED TO DIFFERENTIAL CONVERSION

For many applications, it is required to convert a single-ended signal to a differential signal. The LME49724 can be used for a high performance, simple single-to-differential converter. Figure 3 shows the typical single-to-differential converter circuit configuration.

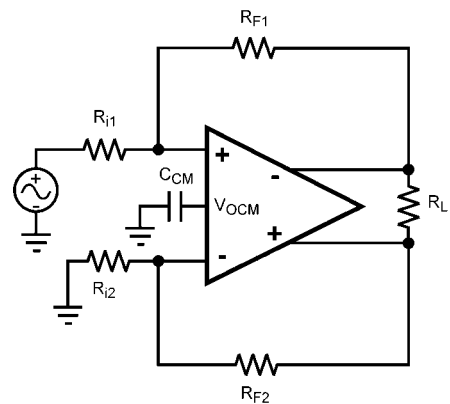

300442s0

FIGURE 3. Single-Ended Input to Differential Output

SINGLE SUPPLY OPERATION

The LME49724 can be operated from a single power supply, as shown in Figure 4. The supply voltage range is limited to a minimum of 5V and a maximum of 36V. The common-mode output DC voltage will be set to the midpoint of the supply voltage. The V_{OCM} pin can be used to adjust the common-mode output DC voltage on the outputs, as described previously, if the supply voltage midpoint is not the desired DC voltage.

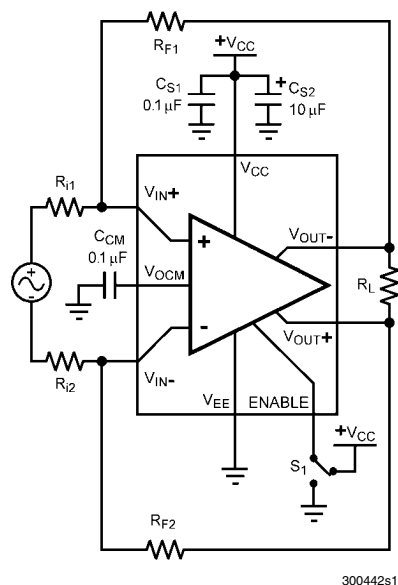

FIGURE 4. Single Supply Configuration

DRIVING A CAPACITIVE LOAD

The LME49724 is a high speed op amp with excellent phase margin and stability. Capacitive loads up to 100pF will cause little change in the phase characteristics of the amplifiers and are therefore allowable.

Capacitive loads greater than 100pF must be isolated from the output. The most straightforward way to do this is to put a resistor in series with the output. This resistor will also prevent excess power dissipation if the output is accidentally shorted.

THERMAL PCB DESIGN

The LME49724's high operating supply voltage along with its high output current capability can result in significant power dissipation. For this reason the LME49724 is provided in the exposed DAP MSOP (PSOP) package for improved thermal dissipation performance compared to other surface mount packages. The exposed pad is designed to be soldered to a copper plane on the PCB which then acts as a heat sink. The thermal plane can be on any layer by using multiple thermal vias under and outside the IC package. The vias under the IC should have solder mask openings for the entire pad under the IC on the top layer but cover the vias on the bottom layer. This method prevents solder from being pulled away from the thermal vias during the reflow process resulting in optimum thermal conductivity.

Heat radiation from the PCB plane area is best accomplished when the thermal plane is on the top or bottom copper layers. The LME49724 should always be soldered down to a copper

pad on the PCB for both optimum thermal performance as well as mechanical stability.

The exposed pad is for heat transfer and the thermal plane should either be electrically isolated or connected to the same potential as the V_{EE} pin. For high frequency applications ($f > 1\text{MHz}$) or lower impedance loads, the pad should be connected to a plane that is connected to the V_{EE} potential.

SUPPLY BYPASSING

The LME49724 should have its supply leads bypassed with low-inductance capacitors such as leadless surface mount (SMT) capacitors located as close as possible to the supply pins. It is recommended that a 10 μF tantalum or electrolytic capacitor be placed in parallel with a 0.1 μF ceramic or film type capacitor on each supply pin. These capacitors should be star routed with a dedicated ground return plane or large trace for best THD performance. Placing capacitors too far from the power supply pins, especially with thin connecting traces, can lead to excessive inductance, resulting in degraded high-frequency bypassing. Poor high-frequency bypassing can result in circuit instabilities. When using high bandwidth power supplies, the value and number of supply bypass capacitors should be reduced for optimal power supply performance.

BALANCE CABLE DRIVER

With high peak-to-peak differential output voltage and plenty of low distortion drive current, the LME49724 makes an excellent balanced cable driver. Combining the single-to-differential configuration with a balanced cable driver results in a high performance single-ended input to balanced line driver solution.

Although the LME49724 can drive capacitive loads up to 100pF, cable loads exceeding 100pF can cause instability. For such applications, series resistors are needed on the outputs before the capacitive load.

ANALOG-TO-DIGITAL CONVERTER (ADC) APPLICATION

Figure 5 is a typical fully differential application circuit for driving an analog-to-digital converter (ADC). The additional components of R_5 , R_6 , and C_7 are optional components and are for stability and proper ADC sampling. ADC's commonly use switched capacitor circuitry at the input. When the ADC samples the signal the current momentarily increases and may disturb the signal integrity at the sample point causing a signal glitch. Component C_7 is significantly larger than the input capacitance of a typical ADC and acts as a charge reservoir greatly reducing the effect of the signal sample by the ADC. Resistors R_5 and R_6 decouple the capacitive load, C_7 , for stability. The values shown are general values. Specific values should be optimized for the particular ADC loading requirements.

The output reference voltage from the ADC can be used to drive the V_{OCM} pin to set the common-mode DC voltage on the outputs of the LME49724. A buffer may be needed to drive the LME49724's V_{OCM} pin if the ADC cannot drive the 50k Ω input impedance of the V_{OCM} pin.

In order to minimize circuit distortion when using capacitors in the signal path, the capacitors should be comprised of either NPO ceramic, polystyrene, polypropylene or mica composition. Other types of capacitors may provide a reduced distortion performance but for a cost improvement, so capacitor selection is dependent upon design requirements. The performance/cost tradeoff for a specific application is left up to the user.

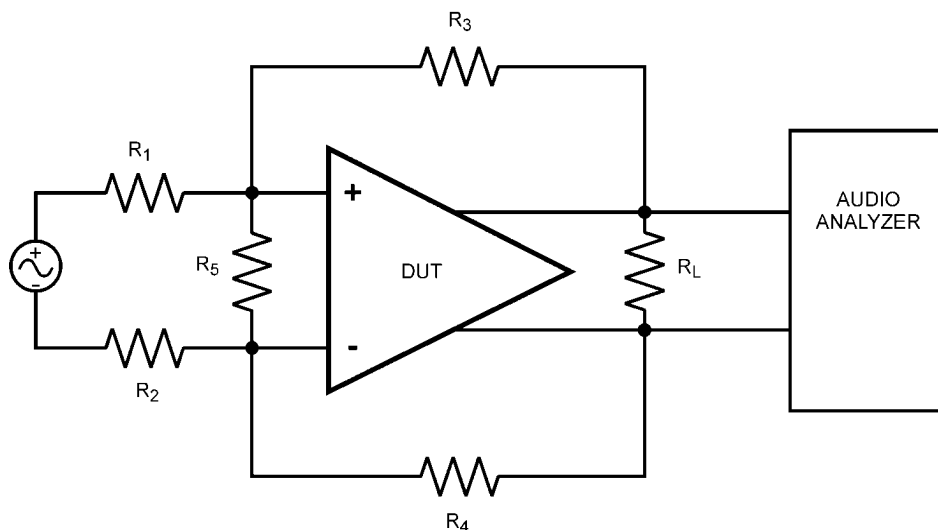

300442r5

FIGURE 6. THD+N and IMD Distortion Test Circuit

PERFORMANCE VARIATIONS

The LME49724 has excellent performance with little variation across different supply voltages, load impedances, and input configuration (single-ended or differential). Inspection of the THD+N vs Frequency and THD+N vs Output Voltage performance graphs reveals only minimal differences with different load values. Figures 7 and 8 below show the performance across different supply voltages with the same output signal level and load. Figure 7 has plots at $\pm 5V$, $\pm 12V$, $\pm 15V$, and $\pm 18V$ with a $3V_{RMS}$ output while Figure 8 has plots at $\pm 12V$, $\pm 15V$, and $\pm 18V$ with a $10V_{RMS}$ output. Both figures use a 600Ω load. The performance for each different supply voltage under the same conditions is so similar it is nearly impossible to discern the different plots lines.

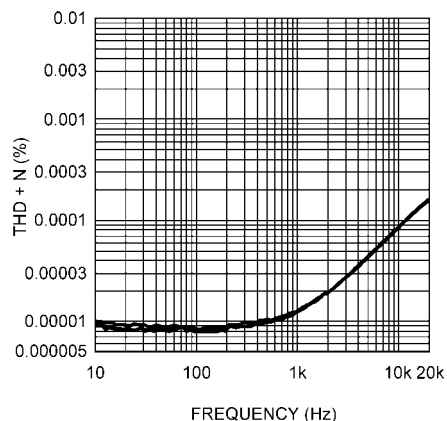

300442x4

**FIGURE 8. THD+N vs FREQUENCY with $R_L = 600\Omega$
 $V_{OUT} = 10V_{RMS}$, Differential Input, 80kHz BW
 $V_S = \pm 12V, \pm 15V, \text{ and } \pm 18V$**

Whether the input configuration is single-ended or differential has only a minimal affect on THD+N performance at higher audio frequencies or higher signal levels. For easy comparison, Figures 9 and 10 are a combination of the performance graphs found in the *Typical Performance Characteristics* section above.

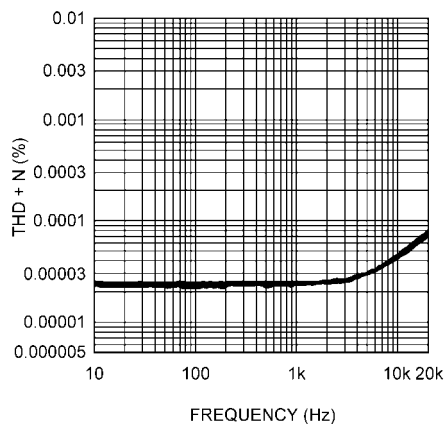

300442x5

**FIGURE 7. THD+N vs FREQUENCY with $R_L = 600\Omega$
 $V_{OUT} = 3V_{RMS}$, Differential Input, 80kHz BW
 $V_S = \pm 5V, \pm 12V, \pm 15V, \text{ and } \pm 18V$**

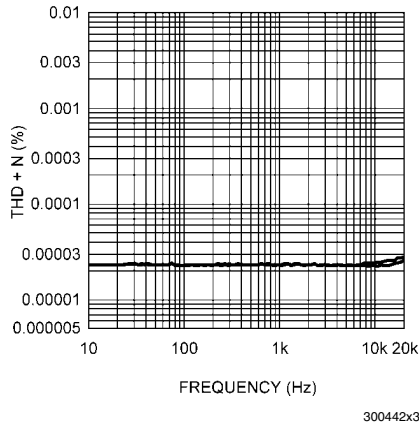

**FIGURE 9. THD+N vs FREQUENCY with $R_L = 10k\Omega$
 $V_{OUT} = 3V_{RMS}$, $V_S = \pm 15V$, 80kHz BW
 Single-ended and Differential Input**

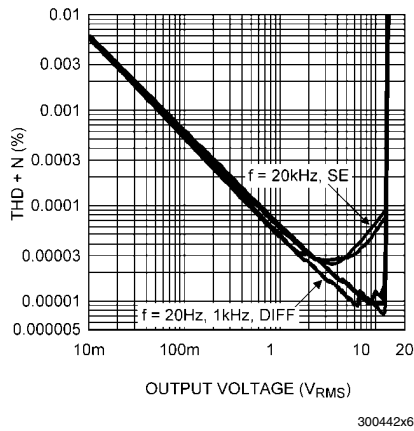

**FIGURE 10. THD+N vs OUTPUT VOLTAGE with $R_L = 10k\Omega$
 $f = 20Hz, 1kHz, 20kHz$, $V_S = \pm 15V$, 80kHz BW
 Single-ended and Differential Input**

Power Supply Rejection Ratio does not vary with load value nor supply voltage. For easy comparison, Figures 11 and 12 below are created by combining performance graphs found in the *Typical Performance Characteristics* section above.

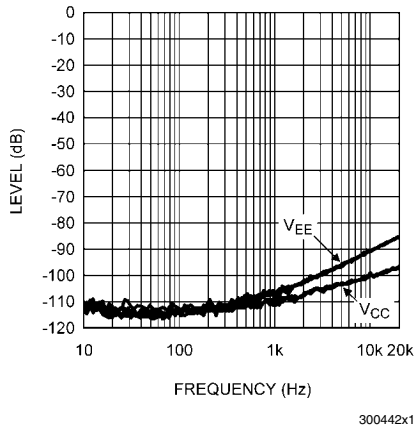
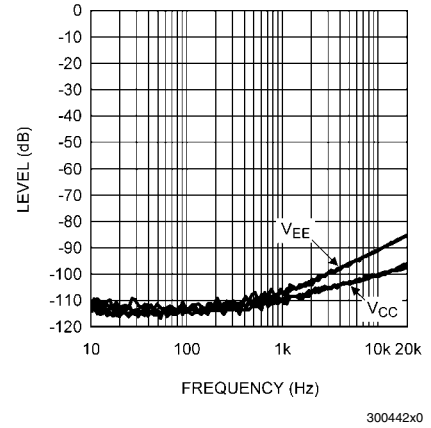

FIGURE 11. PSRR vs FREQUENCY with $R_L = 600\Omega$

$V_S = \pm 2.5V, \pm 15V, \text{ and } \pm 18V, 80kHz BW$



**FIGURE 12. PSRR vs FREQUENCY with $V_S = \pm 15V$
 $R_L = 600\Omega, 2k\Omega, \text{ and } 10k\Omega, 80kHz BW$**

Although supply current may not be a critical specification for many applications, there is also no real variation in supply current with no load or with a 600Ω load. This is a result of the extremely low offset voltage, typically less than 1mV. Figure 13 shows the supply current under the two conditions with no real difference discernable.

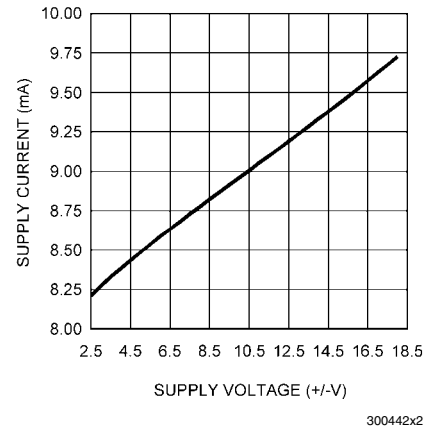

**FIGURE 13. Supply Current vs Supply Voltage
 $R_L = \text{No Load and } 600\Omega$**

Demo Board Schematic

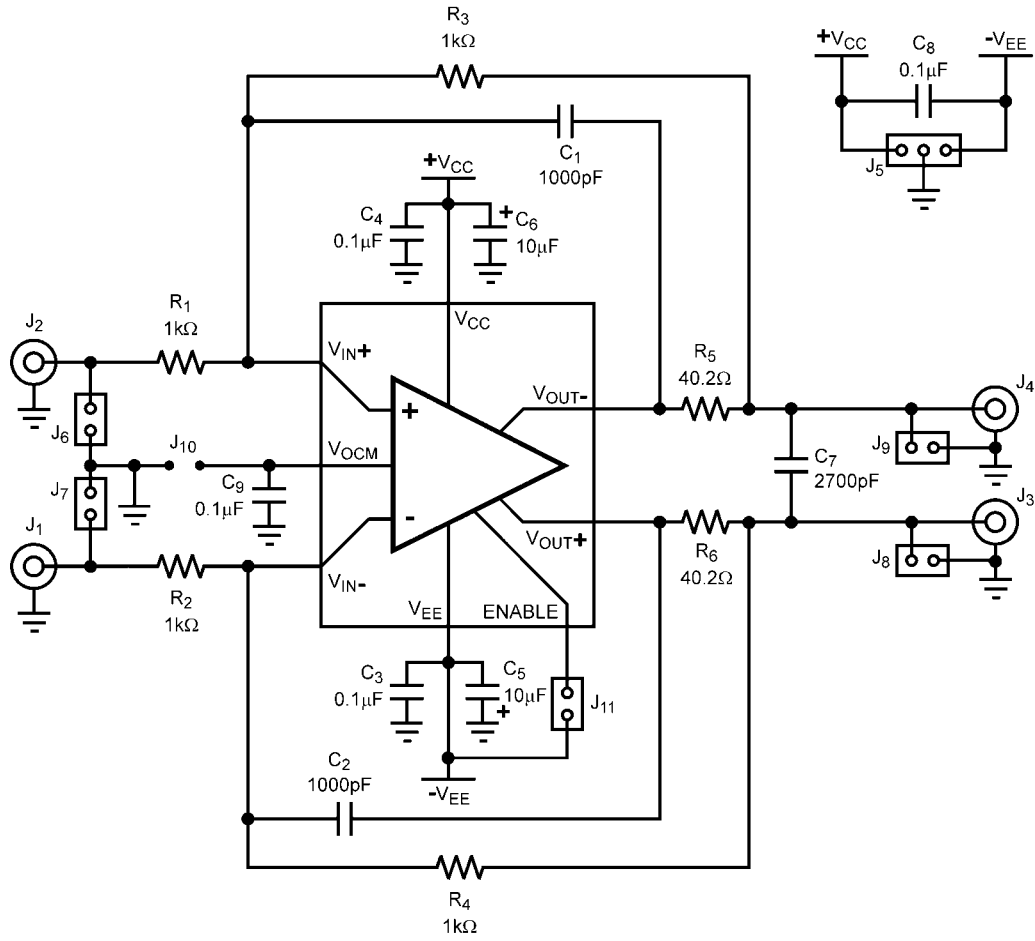

300442w8

FIGURE 14. Demonstration Board Circuit

Build of Materials

TABLE 1. Reference Demo Board Bill of Materials

Designator	Value	Tolerance	Part Description	Comment
R ₁ , R ₂ , R ₃ , R ₄	1k Ω	1%	1/8W, 0603 Resistor	
R ₅ , R ₆	40.2 Ω	1%	1/8W, 0603 Resistor	
C ₁ , C ₂	1000pF	10%	0603, NPO Ceramic Capacitor, 50V	
C ₃ , C ₄ , C ₈ , C ₉	0.1 μ F	-20%, +80%	0603, Y5V Ceramic Capacitor, 25V	
C ₅ , C ₆	10 μ F	20%	Size C (6032), Tantalum Capacitor, 25V	
C ₇	2700pF	10%	0805, NPO Ceramic Capacitor, 50V	
U ₁			LME49724MR	
J ₁ , J ₂ , J ₃ , J ₄			SMA coaxial connector	Inputs & Outputs
J ₅			0.100" 1x3 header, vertical mount	V _{DD} , V _{EE} , GND
J ₆ , J ₇ , J ₈ , J ₉ , J ₁₀ , J ₁₁			0.100" 1x2 header, vertical mount	Inputs, Outputs, V _{OCM} , Enable

Revision History

Rev	Date	Description
1.0	11/12/08	Initial release.

Notes

LME49724

Notes

For more National Semiconductor product information and proven design tools, visit the following Web sites at:

Products		Design Support	
Amplifiers	www.national.com/amplifiers	WEBENCH® Tools	www.national.com/webench
Audio	www.national.com/audio	App Notes	www.national.com/appnotes
Clock and Timing	www.national.com/timing	Reference Designs	www.national.com/refdesigns
Data Converters	www.national.com/adc	Samples	www.national.com/samples
Interface	www.national.com/interface	Eval Boards	www.national.com/evalboards
LVDS	www.national.com/lvds	Packaging	www.national.com/packaging
Power Management	www.national.com/power	Green Compliance	www.national.com/quality/green
Switching Regulators	www.national.com/switchers	Distributors	www.national.com/contacts
LDOs	www.national.com/ldo	Quality and Reliability	www.national.com/quality
LED Lighting	www.national.com/led	Feedback/Support	www.national.com/feedback
Voltage Reference	www.national.com/vref	Design Made Easy	www.national.com/easy
PowerWise® Solutions	www.national.com/powerwise	Solutions	www.national.com/solutions
Serial Digital Interface (SDI)	www.national.com/sdi	Mil/Aero	www.national.com/milaero
Temperature Sensors	www.national.com/tempsensors	Solar Magic®	www.national.com/solarmagic
Wireless (PLL/VCO)	www.national.com/wireless	Analog University®	www.national.com/AU

THE CONTENTS OF THIS DOCUMENT ARE PROVIDED IN CONNECTION WITH NATIONAL SEMICONDUCTOR CORPORATION ("NATIONAL") PRODUCTS. NATIONAL MAKES NO REPRESENTATIONS OR WARRANTIES WITH RESPECT TO THE ACCURACY OR COMPLETENESS OF THE CONTENTS OF THIS PUBLICATION AND RESERVES THE RIGHT TO MAKE CHANGES TO SPECIFICATIONS AND PRODUCT DESCRIPTIONS AT ANY TIME WITHOUT NOTICE. NO LICENSE, WHETHER EXPRESS, IMPLIED, ARISING BY ESTOPPEL OR OTHERWISE, TO ANY INTELLECTUAL PROPERTY RIGHTS IS GRANTED BY THIS DOCUMENT.

TESTING AND OTHER QUALITY CONTROLS ARE USED TO THE EXTENT NATIONAL DEEMS NECESSARY TO SUPPORT NATIONAL'S PRODUCT WARRANTY. EXCEPT WHERE MANDATED BY GOVERNMENT REQUIREMENTS, TESTING OF ALL PARAMETERS OF EACH PRODUCT IS NOT NECESSARILY PERFORMED. NATIONAL ASSUMES NO LIABILITY FOR APPLICATIONS ASSISTANCE OR BUYER PRODUCT DESIGN. BUYERS ARE RESPONSIBLE FOR THEIR PRODUCTS AND APPLICATIONS USING NATIONAL COMPONENTS. PRIOR TO USING OR DISTRIBUTING ANY PRODUCTS THAT INCLUDE NATIONAL COMPONENTS, BUYERS SHOULD PROVIDE ADEQUATE DESIGN, TESTING AND OPERATING SAFEGUARDS.

EXCEPT AS PROVIDED IN NATIONAL'S TERMS AND CONDITIONS OF SALE FOR SUCH PRODUCTS, NATIONAL ASSUMES NO LIABILITY WHATSOEVER, AND NATIONAL DISCLAIMS ANY EXPRESS OR IMPLIED WARRANTY RELATING TO THE SALE AND/OR USE OF NATIONAL PRODUCTS INCLUDING LIABILITY OR WARRANTIES RELATING TO FITNESS FOR A PARTICULAR PURPOSE, MERCHANTABILITY, OR INFRINGEMENT OF ANY PATENT, COPYRIGHT OR OTHER INTELLECTUAL PROPERTY RIGHT.

LIFE SUPPORT POLICY

NATIONAL'S PRODUCTS ARE NOT AUTHORIZED FOR USE AS CRITICAL COMPONENTS IN LIFE SUPPORT DEVICES OR SYSTEMS WITHOUT THE EXPRESS PRIOR WRITTEN APPROVAL OF THE CHIEF EXECUTIVE OFFICER AND GENERAL COUNSEL OF NATIONAL SEMICONDUCTOR CORPORATION. As used herein:

Life support devices or systems are devices which (a) are intended for surgical implant into the body, or (b) support or sustain life and whose failure to perform when properly used in accordance with instructions for use provided in the labeling can be reasonably expected to result in a significant injury to the user. A critical component is any component in a life support device or system whose failure to perform can be reasonably expected to cause the failure of the life support device or system or to affect its safety or effectiveness.

National Semiconductor and the National Semiconductor logo are registered trademarks of National Semiconductor Corporation. All other brand or product names may be trademarks or registered trademarks of their respective holders.

Copyright© 2008 National Semiconductor Corporation

For the most current product information visit us at www.national.com



National Semiconductor Americas Technical Support Center
 Email: support@nsc.com
 Tel: 1-800-272-9959

National Semiconductor Europe Technical Support Center
 Email: europe.support@nsc.com
 German Tel: +49 (0) 180 5010 771
 English Tel: +44 (0) 870 850 4288

National Semiconductor Asia Pacific Technical Support Center
 Email: ap.support@nsc.com

National Semiconductor Japan Technical Support Center
 Email: jpn.feedback@nsc.com

IMPORTANT NOTICE

Texas Instruments Incorporated and its subsidiaries (TI) reserve the right to make corrections, modifications, enhancements, improvements, and other changes to its products and services at any time and to discontinue any product or service without notice. Customers should obtain the latest relevant information before placing orders and should verify that such information is current and complete. All products are sold subject to TI's terms and conditions of sale supplied at the time of order acknowledgment.

TI warrants performance of its hardware products to the specifications applicable at the time of sale in accordance with TI's standard warranty. Testing and other quality control techniques are used to the extent TI deems necessary to support this warranty. Except where mandated by government requirements, testing of all parameters of each product is not necessarily performed.

TI assumes no liability for applications assistance or customer product design. Customers are responsible for their products and applications using TI components. To minimize the risks associated with customer products and applications, customers should provide adequate design and operating safeguards.

TI does not warrant or represent that any license, either express or implied, is granted under any TI patent right, copyright, mask work right, or other TI intellectual property right relating to any combination, machine, or process in which TI products or services are used. Information published by TI regarding third-party products or services does not constitute a license from TI to use such products or services or a warranty or endorsement thereof. Use of such information may require a license from a third party under the patents or other intellectual property of the third party, or a license from TI under the patents or other intellectual property of TI.

Reproduction of TI information in TI data books or data sheets is permissible only if reproduction is without alteration and is accompanied by all associated warranties, conditions, limitations, and notices. Reproduction of this information with alteration is an unfair and deceptive business practice. TI is not responsible or liable for such altered documentation. Information of third parties may be subject to additional restrictions.

Resale of TI products or services with statements different from or beyond the parameters stated by TI for that product or service voids all express and any implied warranties for the associated TI product or service and is an unfair and deceptive business practice. TI is not responsible or liable for any such statements.

TI products are not authorized for use in safety-critical applications (such as life support) where a failure of the TI product would reasonably be expected to cause severe personal injury or death, unless officers of the parties have executed an agreement specifically governing such use. Buyers represent that they have all necessary expertise in the safety and regulatory ramifications of their applications, and acknowledge and agree that they are solely responsible for all legal, regulatory and safety-related requirements concerning their products and any use of TI products in such safety-critical applications, notwithstanding any applications-related information or support that may be provided by TI. Further, Buyers must fully indemnify TI and its representatives against any damages arising out of the use of TI products in such safety-critical applications.

TI products are neither designed nor intended for use in military/aerospace applications or environments unless the TI products are specifically designated by TI as military-grade or "enhanced plastic." Only products designated by TI as military-grade meet military specifications. Buyers acknowledge and agree that any such use of TI products which TI has not designated as military-grade is solely at the Buyer's risk, and that they are solely responsible for compliance with all legal and regulatory requirements in connection with such use.

TI products are neither designed nor intended for use in automotive applications or environments unless the specific TI products are designated by TI as compliant with ISO/TS 16949 requirements. Buyers acknowledge and agree that, if they use any non-designated products in automotive applications, TI will not be responsible for any failure to meet such requirements.

Following are URLs where you can obtain information on other Texas Instruments products and application solutions:

Products

Audio	www.ti.com/audio
Amplifiers	amplifier.ti.com
Data Converters	dataconverter.ti.com
DLP® Products	www.dlp.com
DSP	dsp.ti.com
Clocks and Timers	www.ti.com/clocks
Interface	interface.ti.com
Logic	logic.ti.com
Power Mgmt	power.ti.com
Microcontrollers	microcontroller.ti.com
RFID	www.ti-rfid.com
OMAP Mobile Processors	www.ti.com/omap
Wireless Connectivity	www.ti.com/wirelessconnectivity

Applications

Communications and Telecom	www.ti.com/communications
Computers and Peripherals	www.ti.com/computers
Consumer Electronics	www.ti.com/consumer-apps
Energy and Lighting	www.ti.com/energy
Industrial	www.ti.com/industrial
Medical	www.ti.com/medical
Security	www.ti.com/security
Space, Avionics and Defense	www.ti.com/space-avionics-defense
Transportation and Automotive	www.ti.com/automotive
Video and Imaging	www.ti.com/video

TI E2E Community Home Page

e2e.ti.com

Mailing Address: Texas Instruments, Post Office Box 655303, Dallas, Texas 75265
Copyright © 2011, Texas Instruments Incorporated