

257-059

OMRON

PCB Relay

G2VN

Miniature Relay Suitable for Sensitive Signal Circuits

- Low power consumption: 150 mW.
- Wide switching capacity of 10 μ A to 2 A.
- International 2.54-mm terminal pitch.
- Impulse withstand voltage meets FCC Part 68 requirements.
- Flux-tight and plastic-sealed constructions available.

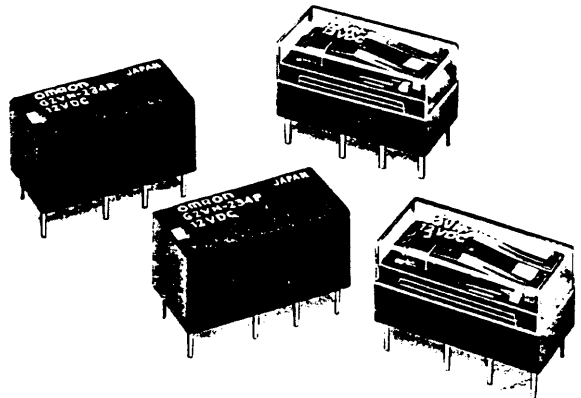

Ordering Information

OMRON Standard

Contact		General-purpose		High-sensitivity	
		Flux-tight	Plastic-sealed	Flux-tight	Plastic-sealed
DPDT	Bifurcated crossbar	G2VN-237P	G2VN-234P	G2VN-237PH	G2VN-234PH
	Single crossbar	G2VN-287P	G2VN-284P	G2VN-287PH	G2VN-284PH

UL/CSA Approved

Contact		General-purpose		High-sensitivity	
		Flux-tight	Plastic-sealed	Flux-tight	Plastic-sealed
DPDT	Bifurcated crossbar	G2VN-237P-US	G2VN-234P-US	G2VN-237PH-US	G2VN-234PH-US
	Single crossbar	G2VN-287P-US	G2VN-284P-US	G2VN-287PH-US	G2VN-284PH-US

Note: When ordering, add the rated coil voltage to the model number.
 Example: G2VN-237P 12 VDC

Rated coil voltage

Model Number Legend:

G2VN - - VDC
 1 2 3 4 5 6 7

- | | | |
|---|--|---|
| <p>1. Contact Form
2: DPDT</p> <p>2. Contact Type
3: Bifurcated crossbar (Au-clad)
8: Single crossbar (Au-clad)</p> <p>3. Enclosure Rating
4: Plastic-sealed
7: Flux-tight</p> | <p>4. Terminals
P: Straight PCB
C: Curved tail PCB</p> <p>5. Power Consumption
None: General-purpose (360 mW)
H: High-sensitivity (150 mW)</p> | <p>6. Approved Standards
None: Not certified (OMRON standard)
US: UL, CSA, TÜV certified</p> <p>7. Rated Coil Voltage
3.5, 4.5, 5, 6, 9, 12, 24, 48 VDC</p> |
|---|--|---|

Specifications

■ Coil Ratings

General-purpose Type

Rated voltage	3 VDC	4.5 VDC	5 VDC	6 VDC	9 VDC	12 VDC	24 VDC	48 VDC
Rated current	120 mA	80 mA	72 mA	60 mA	40 mA	30 mA	15 mA	7.5 mA
Coil resistance	25 Ω	56 Ω	69 Ω	100 Ω	225 Ω	400 Ω	1,600 Ω	6,400 Ω
Coil inductance (H) (ref. value)	Armature OFF	0.058	0.14	0.18	0.26	0.61	1.15	22
	Armature ON	0.068	0.16	0.195	0.28	0.64	1.15	18
Must operate voltage	75% max. of rated voltage							
Must release voltage	10% min. of rated voltage							
Max. voltage	130% of rated voltage at 23°C, 115% at 70°C							
Power consumption	Approx. 360 mW							

High-sensitivity Type

Rated voltage	3 VDC	4.5 VDC	5 VDC	6 VDC	9 VDC	12 VDC	24 VDC	48 VDC
Rated current	50 mA	33 mA	30 mA	25 mA	16.7 mA	12.5 mA	6.63 mA	3.3 mA
Coil resistance	60 Ω	135 Ω	167 Ω	240 Ω	540 Ω	960 Ω	3,840 Ω	14,400 Ω
Coil inductance (H) (ref. value)	Armature OFF	0.165	0.35	0.44	0.64	1.55	2.95	10.27
	Armature ON	0.286	0.64	0.82	1.15	2.6	4.8	19
Must operate voltage	75% max. of rated voltage							
Must release voltage	10% min. of rated voltage							
Max. voltage	200% of rated voltage at 23°C, 150% at 70°C							
Power consumption	Approx. 150 mW							

- Note: 1. The rated current and coil resistance are measured at a coil temperature of 23°C with a tolerance of $\pm 10\%$.
2. Operating characteristics are measured at a coil temperature of 23°C.

■ Contact Ratings

Item	Single crossbar		Bifurcated crossbar	
	Resistive load ($\cos\phi = 1$)	Inductive load ($\cos\phi = 0.4$; L/R = 7 ms)	Resistive load ($\cos\phi = 1$)	Inductive load ($\cos\phi = 0.4$; L/R = 7 ms)
Rated load	0.3 A at 110 VAC; 1 A at 24 VDC	0.2 A at 110 VAC; 0.3 A at 24 VDC	0.3 A at 110 VAC; 1 A at 24 VDC	0.2 A at 110 VAC; 0.3 A at 24 VDC
Contact material	AgPd (Au-clad)			
Rated carry current	2 A			
Max. switching voltage	125 VAC, 125 VDC			
Max. switching current	2 A			
Max. switching capacity	60 VA, 30 W	22 VA, 10 W	60 VA, 30 W	22 VA, 10 W
Min. permissible load	1 mA at 1 VDC (10 μ A at 10 mVDC)		10 μ A at 100 mVDC (10 μ A at 10 mVDC)	

Note: P level: $\lambda_{60} = 0.1 \times 10^{-6}$ /operation

■ Characteristics

Contact resistance	50 mΩ max. (approx. 30 mΩ)
Operate (set) time	7 ms max. (mean value: approx. 5 ms)
Release (reset) time	3 ms max. (mean value: approx. 1 ms)
Bounce time	Operate: 5 ms max. (high-sensitivity type: approx. 0.4 ms) Release: 5 ms max. (high-sensitivity type: approx. 2 ms)
Max. operating frequency	Mechanical: 36,000 operations/hr Electrical: 3,600 operations/hr (under rated load)
Insulation resistance	100 MΩ min. (at 500 VDC)
Dielectric withstand voltage	1,000 VAC, 50/60 Hz for 1 min between coil and contacts 1,000 VAC, 50/60 Hz for 1 min between contacts of different polarity 700 VAC, 50/60 Hz for 1 min between contacts of same polarity
Impulse withstand voltage	1,500 V 10 x 160 μs (conforms to Part 68 of FCC Rules)
Vibration resistance	Destruction: 10 to 55 Hz, 1.5-mm double amplitude Malfunction: 10 to 55 Hz, 1.5-mm double amplitude
Shock resistance	Destruction: 1,000 m/s ² (approx. 100G) Malfunction: NO: 500 m/s ² (approx. 50G); NC: 200 m/s ² (approx. 20G)
Life expectancy	Mechanical: 15,000,000 operations min. (at 36,000 operations/hr) Electrical: 200,000 operations min. (at 3,600 operations/hr)
Ambient temperature	Operating: -25° to 70°C (with no icing) Storage: ntlp
Ambient humidity	35% to 85%
Weight	Approx. 5 g

■ Approved Standards

UL114, UL478, UL1950 (File No. E41515)/CSA C22.2 No.0, No.14 (File No. LR34815-109)

Model	Contact form	Coil ratings	Contact ratings
G2VN-237P-US G2VN-234P-US G2VN-237PH-US G2VN-234PH-US G2VN-287P-US G2VN-284P-US G2VN-287PH-US G2VN-284PH-US G2VN-237PL-US G2VN-287PL-US G2VN-234PL-US G2VN-284PL-US	DPDT	3 to 48 VDC	0.5 A, 120 VAC (general use) 1.5 A, 30 VDC (resistive load)

VDE D435 T201/5.83 = IEC255-1-00

Note: Spacing VDE0110 B/30
Class I equipment use

Model	Contact form	Coil ratings	Contact ratings
G2VN-234P-US	DPDT	5, 12, 24 V ⁻	2 A, 30 V [∨] (cosφ = 1) 0.5 A, 30 V [∨] (cosφ = 0.4) 0.83 A, 36 V ⁻ (0 m sec) 0.1 A, 36 V ⁻ (40 m sec)

Engineering Data

Max. Switching Capacity G2VN-237P, G2VN-287P

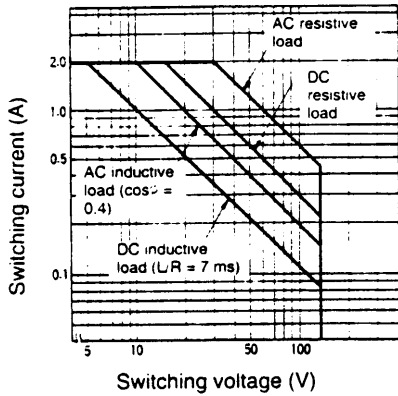

Life Expectancy G2VN-237P, G2VN-287P

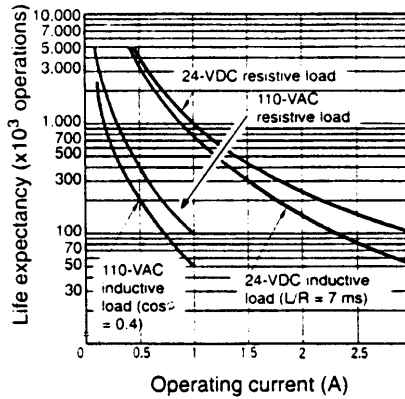

Ambient Temperature vs. Maximum Voltage

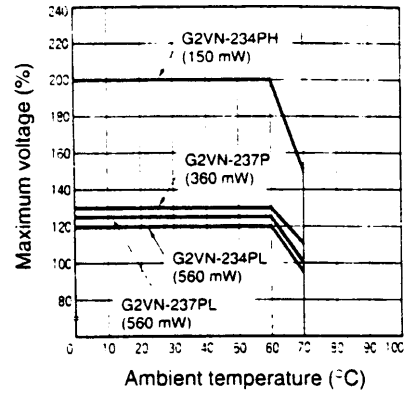

Dimensions

- Note:** 1. All units are in millimeters unless otherwise indicated.
2. Orientation marks are indicated as follows:

Flux-tight

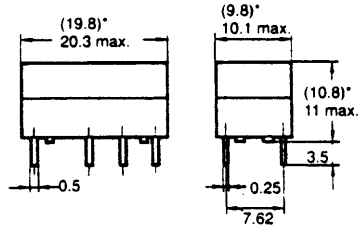
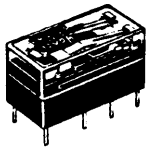

Terminal Arrangement/ Internal Connections (Bottom View)

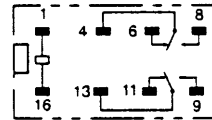

Plastic-sealed

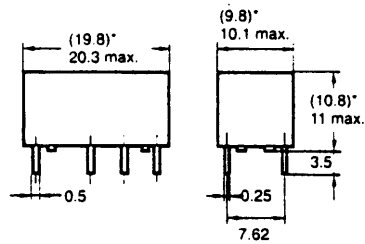
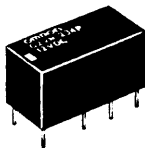

*Average value

Mounting Holes (Bottom View)

Tolerance: ±0.1

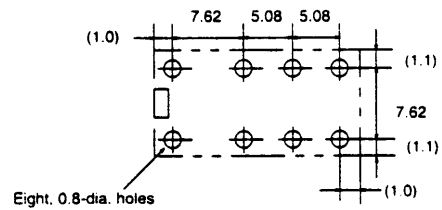

ALL DIMENSIONS SHOWN ARE IN MILLIMETERS.

To convert millimeters into inches, multiply by 0.03937. To convert grams into ounces, multiply by 0.03527.