

True RMS AC Current Transducer

DIN RAIL / PANEL MOUNT, TRUE RMS



CR4110 CR4120
CR4111

Single Element - 0.79" Window
0.5 to 150 AAC Input Range



CR4150 CR4160

Two Element - 0.26" Window
0.5 to 30 AAC Input Range



CR4170 CR4180

Three Element - 0.26" Window
0.5 to 30 AAC Input Range

The **CR4100** Series True RMS Current Transducers and Transmitters are designed for applications where AC current waveforms are not purely sinusoidal. More precise and accurate than other transducers, these devices are ideal in chopped wave and phase fired control systems.

Applications

Phase fired controlled heaters
Quickly varying motor loads
Chopped wave form drivers
Harmonic currents

Features

35mm DIN Rail or Panel Mount
Available with 0-5 VDC, 0-10 VDC, 4-20 mA DC output
24 VDC powered
Use with external current transformers
Highest precision available
Connection diagram printed on case

Regulatory Agencies

Recognized to meet UL 61010B-1
Constructed to meet CAN/CSA-C22.2, No. 61010-1-2004
Meets requirement of IEC 61010-1 and BS EN 61010-1



E199795

Use a 5 Amp Secondary
Current Transformer to extend
the ranges of all CR Magnetics
Current Transducers



All single phase current
transducers are available in split
core design. Simply put an "S" at
the end of the prefix*
I.E. CR4110S-10
*** Not UL Recognized**

Add suffix for input range

PART NUMBERS			
CR4110(S)	-		Single element with 0 - 5 VDC output (split core design)
CR4111(S)	-		Single element with 0 - 10 VDC output (split core design)
CR4120(S)	-		Single element with 4 - 20 mA DC output (split core design)
CR4150	-		Two element with 0 - 5 VDC output **
CR4160	-		Two element with 4 to 20 mA DC output **
CR4170	-		Three element with 0 - 5 VDC output **
CR4180	-		Three element with 4 - 20 mA DC output **

*Two and three element transducers are available only in ranges of 0.5 to 30 AAC

5	-	0- 5 AAC **
10	-	0-10 AAC **
15	-	0-15 AAC **
20	-	0-20 AAC **
25	-	0-25 AAC **
30	-	0-30 AAC **
40	-	0-40 AAC
50	-	0-50 AAC
75	-	0-75 AAC
100	-	0-100 AAC
150	-	0-150 AAC

Ranges available up to and including
600 AAC

SPECIFICATIONS

Basic Accuracy:.....	0.5%	Response Time:.....	250 ms max. 0-90%
Linearity:.....	10% to 100% FS	FS Relative Humidity:.....	80% for temperatures up to 31°C and decreasing linearly to 50% at 40°C
Calibration:.....	True RMS Sensing	Torque Specs:.....	3.0 inch lbs. (0.4Nm)
Thermal Drift:.....	500 PPM/°C	Weight:.....	0.5 lbs.
Operating Temperature:.....	0°C to +60°C	Supply Current:	
Installation Category:.....	CAT II	CR4110/11.....	Typical 15mA Max 25mA
Pollution Degree:.....	2	CR4120.....	Typical 25mA Max 40mA
Insulation Voltage:.....	2500 VDC	CR4150.....	Typical 25mA Max 75mA
Vibration Tested To:.....	IEC 60068-2-6,1995	CR4160.....	Typical 40mA Max 70mA
Altitude:.....	2000 meter max.	CR4170.....	Typical 20mA Max 60mA
Frequency Range:.....	20 Hz - 5 KHz	CR4180.....	Typical 55mA Max 110mA
MTBF:.....	Greater than 100 K hours	CR4110S.....	Typical 15mA Max 25mA
Cleaning:.....	Water-dampened cloth	CR4120S.....	Typical 25mA Max 40mA
Supply Voltage:.....	24 VDC ± 10%		
Output Load:.....	4-20 mADC - 0 to 300 Ω		
	0-5 VDC - 2K Ω or Greater		

Transducers

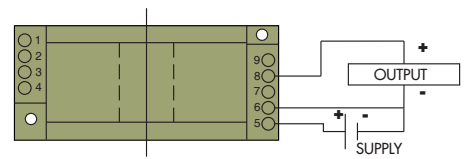
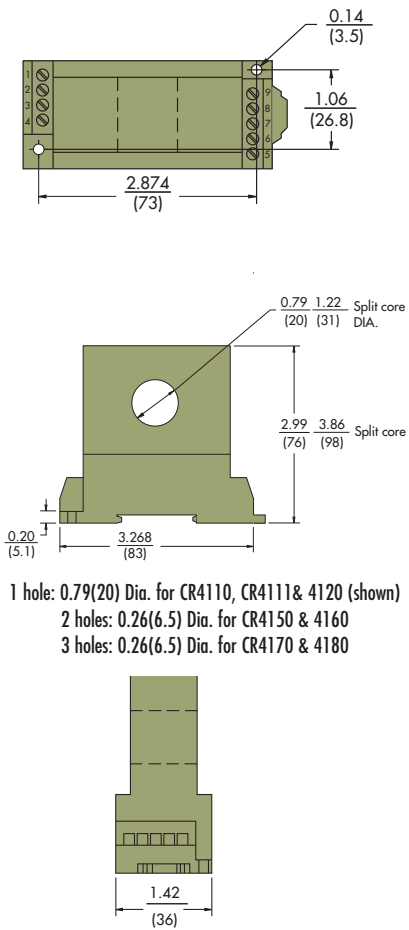

CR4110 One Element 0 - 5 VDC Output
CR4111 One Element 0 - 10 VDC Output

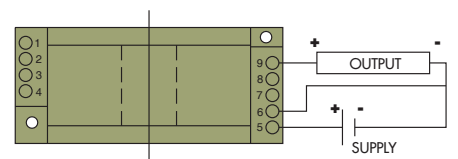

CR4120 One Element 4 - 20 mADC Output

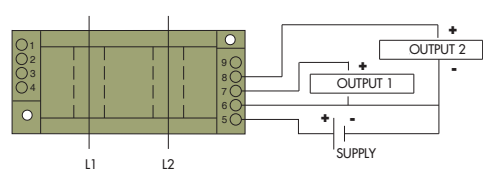

CR4150 Two Element 0 - 5 VDC Output

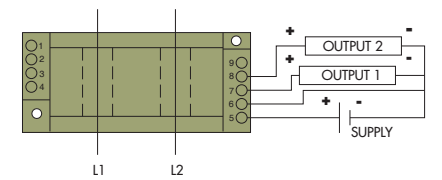

CR4160 Two Element 4 - 20 mADC Output

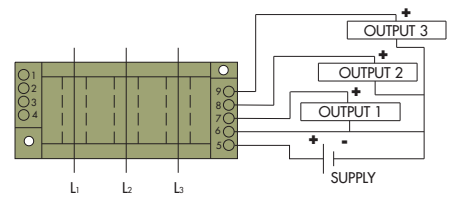

CR4170 Three Element 0 - 5 VDC Output

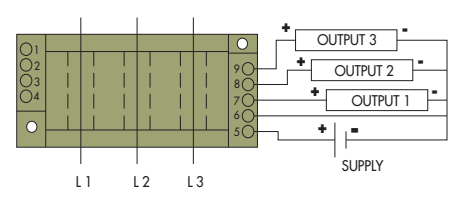

CR4180 Three Element 4 - 20 mADC Output

CONNECTION DIAGRAM

NOTE: The building installation must have a switch or circuit-breaker that is in close proximity and within easy reach of the operator. The switch or circuit breaker shall be marked as the disconnecting device for the equipment.

OUTLINE DRAWING



3500 Scarlet Oak Blvd. St. Louis MO USA 63122 V: 636-343-8518 F: 636-343-5119

Web: <http://www.crmagnetics.com>

E-mail: sales@crmagnetics.com