

# SN54AHC86, SN74AHC86 QUADRUPLE 2-INPUT EXCLUSIVE-OR GATES

SCLS249I – OCTOBER 1995 – REVISED JULY 2003

- Operating Range 2-V to 5.5-V  $V_{CC}$
- Latch-Up Performance Exceeds 250 mA Per JESD 17
- ESD Protection Exceeds JESD 22
  - 2000-V Human-Body Model (A114-A)
  - 200-V Machine Model (A115-A)
  - 1000-V Charged-Device Model (C101)

SN54AHC86 . . . J OR W PACKAGE  
SN74AHC86 . . . D, DB, DGV, N, NS,  
OR PW PACKAGE  
(TOP VIEW)

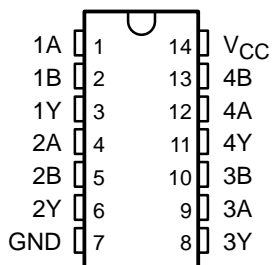

SN74AHC86 . . . RGY PACKAGE  
(TOP VIEW)

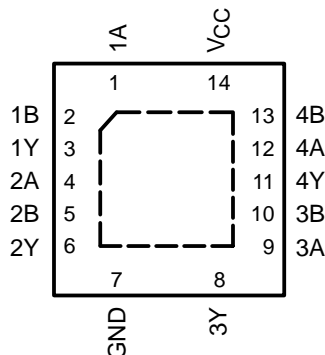

SN54AHC86 . . . FK PACKAGE  
(TOP VIEW)

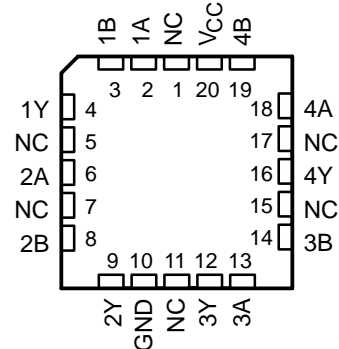

NC – No internal connection

## description/ordering information

The 'AHC86 devices are quadruple 2-input exclusive-OR gates. These devices perform the Boolean function  $Y = A \oplus B$  or  $Y = \overline{A}B + A\overline{B}$  in positive logic.

A common application is as a true/complement element. If one of the inputs is low, the other input is reproduced in true form at the output. If one of the inputs is high, the signal on the other input is reproduced inverted at the output.

## ORDERING INFORMATION

| $T_A$          | PACKAGE†    |               | ORDERABLE PART NUMBER | TOP-SIDE MARKING |
|----------------|-------------|---------------|-----------------------|------------------|
| –40°C to 85°C  | QFN – RGY   | Tape and reel | SN74AHC86RGYR         | HA86             |
|                | PDIP – N    | Tube          | SN74AHC86N            | SN74AHC86N       |
|                | SOIC – D    | Tube          | SN74AHC86D            | AHC86            |
|                |             | Tape and reel | SN74AHC86DR           |                  |
|                | SOP – NS    | Tape and reel | SN74AHC86NSR          | AHC86            |
|                | SSOP – DB   | Tape and reel | SN74AHC86DBR          | HA86             |
|                | TSSOP – PW  | Tube          | SN74AHC86PW           | HA86             |
| Tape and reel  |             | SN74AHC86PWR  |                       |                  |
| –55°C to 125°C | TVSOP – DGV | Tape and reel | SN74AHC86DGV          | HA86             |
|                | CDIP – J    | Tube          | SNJ54AHC86J           | SNJ54AHC86J      |
|                | CFP – W     | Tube          | SNJ54AHC86W           | SNJ54AHC86W      |
|                | LCCC – FK   | Tube          | SNJ54AHC86FK          | SNJ54AHC86FK     |

† Package drawings, standard packing quantities, thermal data, symbolization, and PCB design guidelines are available at [www.ti.com/sc/package](http://www.ti.com/sc/package).



Please be aware that an important notice concerning availability, standard warranty, and use in critical applications of Texas Instruments semiconductor products and disclaimers thereto appears at the end of this data sheet.

PRODUCTION DATA information is current as of publication date. Products conform to specifications per the terms of Texas Instruments standard warranty. Production processing does not necessarily include testing of all parameters.

 **TEXAS  
INSTRUMENTS**

POST OFFICE BOX 655303 • DALLAS, TEXAS 75265

Copyright © 2003, Texas Instruments Incorporated  
On products compliant to MIL-PRF-38535, all parameters are tested unless otherwise noted. On all other products, production processing does not necessarily include testing of all parameters.

# SN54AHC86, SN74AHC86 QUADRUPLE 2-INPUT EXCLUSIVE-OR GATES

SCLS249I – OCTOBER 1995 – REVISED JULY 2003

**FUNCTION TABLE**  
(each gate)

| INPUTS |   | OUTPUT |
|--------|---|--------|
| A      | B | Y      |
| L      | L | L      |
| L      | H | H      |
| H      | L | H      |
| H      | H | L      |

## exclusive-OR logic

An exclusive-OR gate has many applications, some of which can be represented better by alternative logic symbols.

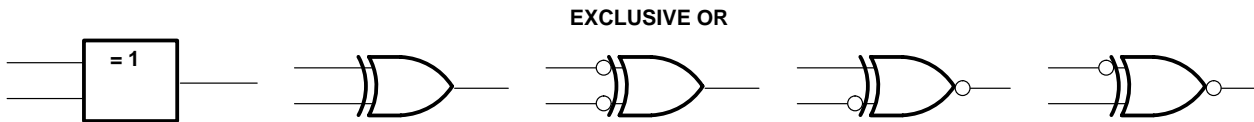

These are five equivalent exclusive-OR symbols valid for an SN74AHC86 gate in positive logic; negation may be shown at any two ports.

**LOGIC-IDENTITY ELEMENT**

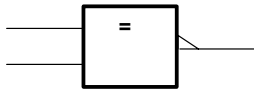

The output is active (low) if all inputs stand at the same logic level (i.e.,  $A = B$ ).

**EVEN-PARITY ELEMENT**

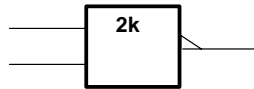

The output is active (low) if an even number of inputs (i.e., 0 or 2) are active.

**ODD-PARITY ELEMENT**

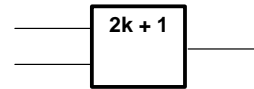

The output is active (high) if an odd number of inputs (i.e., only 1 of the 2) are active.

## absolute maximum ratings over operating free-air temperature range (unless otherwise noted)<sup>†</sup>

|  |                            |
|--|----------------------------|
| Supply voltage range, $V_{CC}$ .....                                   | -0.5 V to 7 V              |
| Input voltage range, $V_I$ (see Note 1) .....                          | -0.5 V to 7 V              |
| Output voltage range, $V_O$ (see Note 1) .....                         | -0.5 V to $V_{CC} + 0.5$ V |
| Input clamp current, $I_{IK}$ ( $V_I < 0$ ) .....                      | -20 mA                     |
| Output clamp current, $I_{OK}$ ( $V_O < 0$ or $V_O > V_{CC}$ ) .....   | $\pm 20$ mA                |
| Continuous output current, $I_O$ ( $V_O = 0$ to $V_{CC}$ ) .....       | $\pm 25$ mA                |
| Continuous current through $V_{CC}$ or GND .....                       | $\pm 50$ mA                |
| Package thermal impedance, $\theta_{JA}$ (see Note 2): D package ..... | 86°C/W                     |
| (see Note 2): DB package .....   | 96°C/W                     |
| (see Note 2): DGV package .....  | 127°C/W                    |
| (see Note 2): N package .....  | 80°C/W                     |
| (see Note 2): NS package .....   | 76°C/W                     |
| (see Note 2): PW package .....   | 113°C/W                    |
| (see Note 3): RGY package .....  | 47°C/W                     |
| Storage temperature range, $T_{stg}$ .....                             | -65°C to 150°C             |

<sup>†</sup> Stresses beyond those listed under "absolute maximum ratings" may cause permanent damage to the device. These are stress ratings only, and functional operation of the device at these or any other conditions beyond those indicated under "recommended operating conditions" is not implied. Exposure to absolute-maximum-rated conditions for extended periods may affect device reliability.

- NOTES: 1. The input and output voltage ratings may be exceeded if the input and output current ratings are observed.  
2. The package thermal impedance is calculated in accordance with JESD 51-7.  
3. The package thermal impedance is calculated in accordance with JESD 51-5.

# SN54AHC86, SN74AHC86 QUADRUPLE 2-INPUT EXCLUSIVE-OR GATES

SCLS249I – OCTOBER 1995 – REVISED JULY 2003

## recommended operating conditions (see Note 4)

|                 |                                    | SN54AHC86                       |                 | SN74AHC86 |                 | UNIT |
|-----------------|------------------------------------|---------------------------------|-----------------|-----------|-----------------|------|
|                 |                                    | MIN                             | MAX             | MIN       | MAX             |      |
| V <sub>CC</sub> | Supply voltage                     | 2                               | 5.5             | 2         | 5.5             | V    |
| V <sub>IH</sub> | High-level input voltage           | V <sub>CC</sub> = 2 V           |                 | 1.5       |                 | V    |
|                 |                                    | V <sub>CC</sub> = 3 V           |                 | 2.1       |                 |      |
|                 |                                    | V <sub>CC</sub> = 5.5 V         |                 | 3.85      |                 |      |
| V <sub>IL</sub> | Low-level input voltage            | V <sub>CC</sub> = 2 V           |                 | 0.5       |                 | V    |
|                 |                                    | V <sub>CC</sub> = 3 V           |                 | 0.9       |                 |      |
|                 |                                    | V <sub>CC</sub> = 5.5 V         |                 | 1.65      |                 |      |
| V <sub>I</sub>  | Input voltage                      | 0                               | 5.5             | 0         | 5.5             | V    |
| V <sub>O</sub>  | Output voltage                     | 0                               | V <sub>CC</sub> | 0         | V <sub>CC</sub> | V    |
| I <sub>OH</sub> | High-level output current          | V <sub>CC</sub> = 2 V           |                 | -50       |                 | μA   |
|                 |                                    | V <sub>CC</sub> = 3.3 V ± 0.3 V |                 | -4        |                 |      |
|                 |                                    | V <sub>CC</sub> = 5 V ± 0.5 V   |                 | -8        |                 |      |
| I <sub>OL</sub> | Low-level output current           | V <sub>CC</sub> = 2 V           |                 | 50        |                 | μA   |
|                 |                                    | V <sub>CC</sub> = 3.3 V ± 0.3 V |                 | 4         |                 |      |
|                 |                                    | V <sub>CC</sub> = 5 V ± 0.5 V   |                 | 8         |                 |      |
| Δt/Δv           | Input transition rise or fall rate | V <sub>CC</sub> = 3.3 V ± 0.3 V |                 | 100       |                 | ns/V |
|                 |                                    | V <sub>CC</sub> = 5 V ± 0.5 V   |                 | 20        |                 |      |
| T <sub>A</sub>  | Operating free-air temperature     | -55                             | 125             | -40       | 85              | °C   |

NOTE 4: All unused inputs of the device must be held at V<sub>CC</sub> or GND to ensure proper device operation. Refer to the TI application report, *Implications of Slow or Floating CMOS Inputs*, literature number SCBA004.

## electrical characteristics over recommended operating free-air temperature range (unless otherwise noted)

| PARAMETER       | TEST CONDITIONS   | V <sub>CC</sub> | T <sub>A</sub> = 25°C |     |      | SN54AHC86 |     | SN74AHC86 |      | UNIT |
|-----------------|---|-----------------|-----------------------|-----|------|-----------|-----|-----------|------|------|
|                 |   |                 | MIN                   | TYP | MAX  | MIN       | MAX | MIN       | MAX  |      |
| V <sub>OH</sub> | I <sub>OH</sub> = -50 μA                                    | 2 V             | 1.9                   | 2   |      | 1.9       |     | 1.9       | V    |      |
|                 |   | 3 V             | 2.9                   | 3   |      | 2.9       |     | 2.9       |      |      |
|                 |   | 4.5 V           | 4.4                   | 4.5 |      | 4.4       |     | 4.4       |      |      |
|                 | I <sub>OH</sub> = -4 mA                                     | 3 V             | 2.58                  |     |      | 2.48      |     | 2.48      |      |      |
|                 | I <sub>OH</sub> = -8 mA                                     | 4.5 V           | 3.94                  |     |      | 3.8       |     | 3.8       |      |      |
| V <sub>OL</sub> | I <sub>OL</sub> = 50 μA                                     | 2 V             |                       |     | 0.1  |           | 0.1 |           | 0.1  | V    |
|                 |   | 3 V             |                       |     | 0.1  |           | 0.1 |           | 0.1  |      |
|                 |   | 4.5 V           |                       |     | 0.1  |           | 0.1 |           | 0.1  |      |
|                 | I <sub>OL</sub> = 4 mA                                      | 3 V             |                       |     | 0.36 |           | 0.5 |           | 0.44 |      |
|                 | I <sub>OL</sub> = 8 mA                                      | 4.5 V           |                       |     | 0.36 |           | 0.5 |           | 0.44 |      |
| I <sub>I</sub>  | V <sub>I</sub> = 5.5 V or GND                               | 0 V to 5.5 V    |                       |     | ±0.1 |           | ±1* |           | ±1   | μA   |
| I <sub>CC</sub> | V <sub>I</sub> = V <sub>CC</sub> or GND, I <sub>O</sub> = 0 | 5.5 V           |                       |     | 2    |           | 20  |           | 20   | μA   |
| C <sub>i</sub>  | V <sub>I</sub> = V <sub>CC</sub> or GND                     | 5 V             |                       |     | 4    | 10        |     |           | 10   | pF   |

\* On products compliant to MIL-PRF-38535, this parameter is not production tested at V<sub>CC</sub> = 0 V.



# SN54AHC86, SN74AHC86 QUADRUPLE 2-INPUT EXCLUSIVE-OR GATES

SCLS2491 – OCTOBER 1995 – REVISED JULY 2003

switching characteristics over recommended operating free-air temperature range,  
 $V_{CC} = 3.3\text{ V} \pm 0.3\text{ V}$  (unless otherwise noted) (see Figure 1)

| PARAMETER | FROM (INPUT) | TO (OUTPUT) | LOAD CAPACITANCE     | $T_A = 25^\circ\text{C}$ |      |     | SN54AHC86 |     | SN74AHC86 |     | UNIT |
|-----------|--------------|-------------|----------------------|--------------------------|------|-----|-----------|-----|-----------|-----|------|
|           |              |             |                      | MIN                      | TYP  | MAX | MIN       | MAX | MIN       | MAX |      |
| $t_{PLH}$ | A or B       | Y           | $C_L = 15\text{ pF}$ | 7*                       | 11*  | 1*  | 13*       | 1   | 13        | ns  |      |
| $t_{PHL}$ |              |             |                      | 7*                       | 11*  | 1*  | 13*       | 1   | 13        |     |      |
| $t_{PLH}$ | A or B       | Y           | $C_L = 50\text{ pF}$ | 9.5                      | 14.5 | 1   | 16.5      | 1   | 16.5      | ns  |      |
| $t_{PHL}$ |              |             |                      | 9.5                      | 14.5 | 1   | 16.5      | 1   | 16.5      |     |      |

\* On products compliant to MIL-PRF-38535, this parameter is not production tested.

switching characteristics over recommended operating free-air temperature range,  
 $V_{CC} = 5\text{ V} \pm 0.5\text{ V}$  (unless otherwise noted) (see Figure 1)

| PARAMETER | FROM (INPUT) | TO (OUTPUT) | LOAD CAPACITANCE     | $T_A = 25^\circ\text{C}$ |      |     | SN54AHC86 |     | SN74AHC86 |     | UNIT |
|-----------|--------------|-------------|----------------------|--------------------------|------|-----|-----------|-----|-----------|-----|------|
|           |              |             |                      | MIN                      | TYP  | MAX | MIN       | MAX | MIN       | MAX |      |
| $t_{PLH}$ | A or B       | Y           | $C_L = 15\text{ pF}$ | 4.8*                     | 6.8* | 1*  | 8*        | 1   | 8         | ns  |      |
| $t_{PHL}$ |              |             |                      | 4.8*                     | 6.8* | 1*  | 8*        | 1   | 8         |     |      |
| $t_{PLH}$ | A or B       | Y           | $C_L = 50\text{ pF}$ | 6.3                      | 8.8  | 1   | 10        | 1   | 10        | ns  |      |
| $t_{PHL}$ |              |             |                      | 6.3                      | 8.8  | 1   | 10        | 1   | 10        |     |      |

\* On products compliant to MIL-PRF-38535, this parameter is not production tested.

noise characteristics,  $V_{CC} = 5\text{ V}$ ,  $C_L = 50\text{ pF}$ ,  $T_A = 25^\circ\text{C}$  (see Note 5)

| PARAMETER   |  | SN74AHC86 |      |     | UNIT |
|-------------|--|-----------|------|-----|------|
|             |  | MIN       | TYP  | MAX |      |
| $V_{OL(P)}$ | Quiet output, maximum dynamic $V_{OL}$ | 0.3       | 0.8  |     | V    |
| $V_{OL(V)}$ | Quiet output, minimum dynamic $V_{OL}$ | -0.3      | -0.8 |     | V    |
| $V_{OH(V)}$ | Quiet output, minimum dynamic $V_{OH}$ | 4.4       |      |     | V    |
| $V_{IH(D)}$ | High-level dynamic input voltage       | 3.5       |      |     | V    |
| $V_{IL(D)}$ | Low-level dynamic input voltage        |           | 1.5  |     | V    |

NOTE 5: Characteristics are for surface-mount packages only.

operating characteristics,  $V_{CC} = 5\text{ V}$ ,  $T_A = 25^\circ\text{C}$

| PARAMETER |                               | TEST CONDITIONS             | TYP | UNIT |
|-----------|-------------------------------|-----------------------------|-----|------|
| $C_{pd}$  | Power dissipation capacitance | No load, $f = 1\text{ MHz}$ | 18  | pF   |



PARAMETER MEASUREMENT INFORMATION

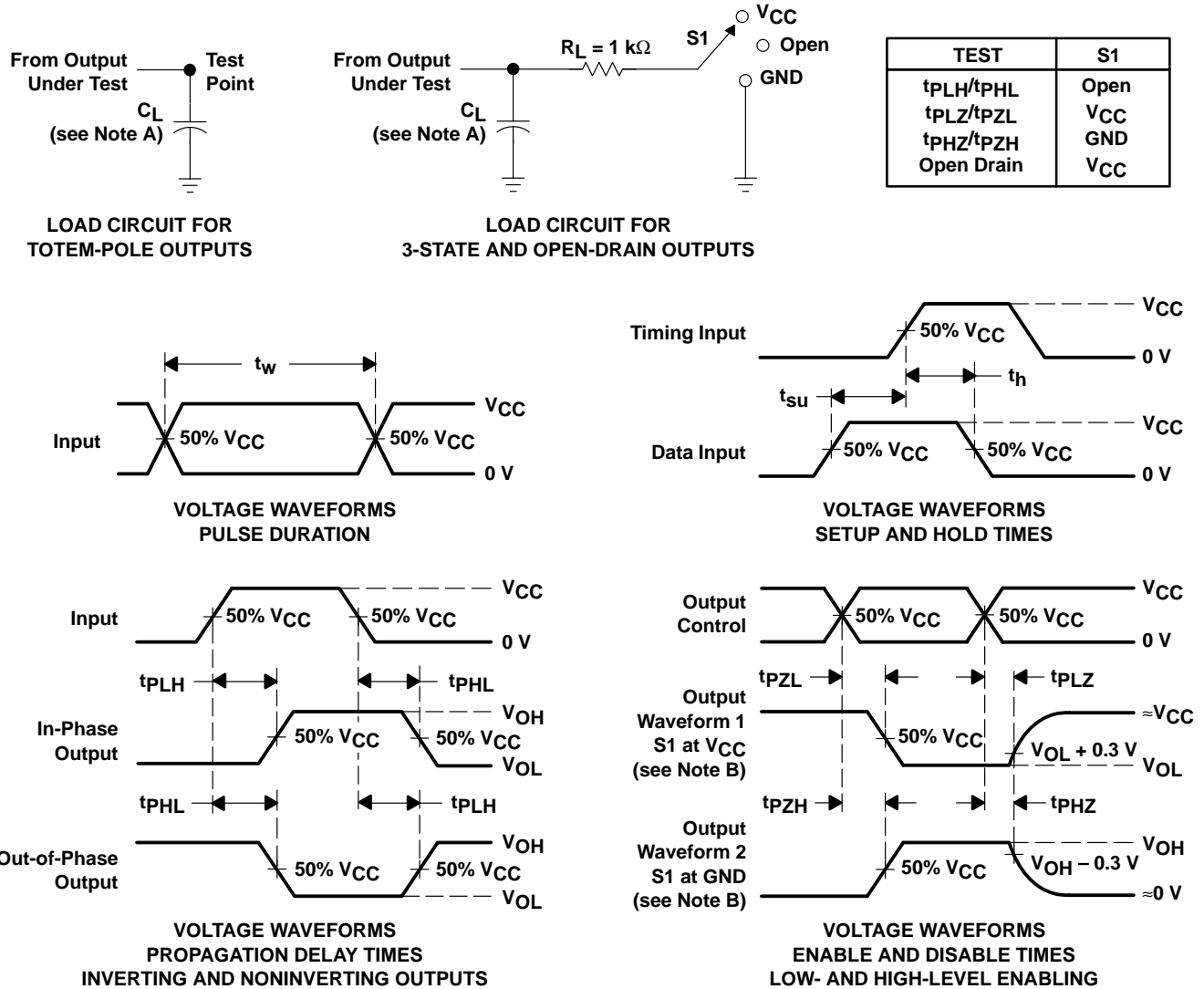

- NOTES:
- A.  $C_L$  includes probe and jig capacitance.
  - B. Waveform 1 is for an output with internal conditions such that the output is low except when disabled by the output control. Waveform 2 is for an output with internal conditions such that the output is high except when disabled by the output control.
  - C. All input pulses are supplied by generators having the following characteristics:  $PRR \leq 1$  MHz,  $Z_O = 50 \Omega$ ,  $t_r \leq 3$  ns,  $t_f \leq 3$  ns.
  - D. The outputs are measured one at a time with one input transition per measurement.
  - E. All parameters and waveforms are not applicable to all devices.

Figure 1. Load Circuit and Voltage Waveforms

## IMPORTANT NOTICE

Texas Instruments Incorporated and its subsidiaries (TI) reserve the right to make corrections, modifications, enhancements, improvements, and other changes to its products and services at any time and to discontinue any product or service without notice. Customers should obtain the latest relevant information before placing orders and should verify that such information is current and complete. All products are sold subject to TI's terms and conditions of sale supplied at the time of order acknowledgment.

TI warrants performance of its hardware products to the specifications applicable at the time of sale in accordance with TI's standard warranty. Testing and other quality control techniques are used to the extent TI deems necessary to support this warranty. Except where mandated by government requirements, testing of all parameters of each product is not necessarily performed.

TI assumes no liability for applications assistance or customer product design. Customers are responsible for their products and applications using TI components. To minimize the risks associated with customer products and applications, customers should provide adequate design and operating safeguards.

TI does not warrant or represent that any license, either express or implied, is granted under any TI patent right, copyright, mask work right, or other TI intellectual property right relating to any combination, machine, or process in which TI products or services are used. Information published by TI regarding third-party products or services does not constitute a license from TI to use such products or services or a warranty or endorsement thereof. Use of such information may require a license from a third party under the patents or other intellectual property of the third party, or a license from TI under the patents or other intellectual property of TI.

Reproduction of information in TI data books or data sheets is permissible only if reproduction is without alteration and is accompanied by all associated warranties, conditions, limitations, and notices. Reproduction of this information with alteration is an unfair and deceptive business practice. TI is not responsible or liable for such altered documentation.

Resale of TI products or services with statements different from or beyond the parameters stated by TI for that product or service voids all express and any implied warranties for the associated TI product or service and is an unfair and deceptive business practice. TI is not responsible or liable for any such statements.

TI products are not authorized for use in safety-critical applications (such as life support) where a failure of the TI product would reasonably be expected to cause severe personal injury or death, unless officers of the parties have executed an agreement specifically governing such use. Buyers represent that they have all necessary expertise in the safety and regulatory ramifications of their applications, and acknowledge and agree that they are solely responsible for all legal, regulatory and safety-related requirements concerning their products and any use of TI products in such safety-critical applications, notwithstanding any applications-related information or support that may be provided by TI. Further, Buyers must fully indemnify TI and its representatives against any damages arising out of the use of TI products in such safety-critical applications.

TI products are neither designed nor intended for use in military/aerospace applications or environments unless the TI products are specifically designated by TI as military-grade or "enhanced plastic." Only products designated by TI as military-grade meet military specifications. Buyers acknowledge and agree that any such use of TI products which TI has not designated as military-grade is solely at the Buyer's risk, and that they are solely responsible for compliance with all legal and regulatory requirements in connection with such use.

TI products are neither designed nor intended for use in automotive applications or environments unless the specific TI products are designated by TI as compliant with ISO/TS 16949 requirements. Buyers acknowledge and agree that, if they use any non-designated products in automotive applications, TI will not be responsible for any failure to meet such requirements.

Following are URLs where you can obtain information on other Texas Instruments products and application solutions:

| <b>Products</b>       |  | <b>Applications</b> |  |
|-----------------------|--|---------------------|--|
| Amplifiers            | <a href="http://amplifier.ti.com">amplifier.ti.com</a>             | Audio               | <a href="http://www.ti.com/audio">www.ti.com/audio</a>                   |
| Data Converters       | <a href="http://dataconverter.ti.com">dataconverter.ti.com</a>     | Automotive          | <a href="http://www.ti.com/automotive">www.ti.com/automotive</a>         |
| DSP                   | <a href="http://dsp.ti.com">dsp.ti.com</a>                         | Broadband           | <a href="http://www.ti.com/broadband">www.ti.com/broadband</a>           |
| Interface             | <a href="http://interface.ti.com">interface.ti.com</a>             | Digital Control     | <a href="http://www.ti.com/digitalcontrol">www.ti.com/digitalcontrol</a> |
| Logic                 | <a href="http://logic.ti.com">logic.ti.com</a>                     | Military            | <a href="http://www.ti.com/military">www.ti.com/military</a>             |
| Power Mgmt            | <a href="http://power.ti.com">power.ti.com</a>                     | Optical Networking  | <a href="http://www.ti.com/opticalnetwork">www.ti.com/opticalnetwork</a> |
| Microcontrollers      | <a href="http://microcontroller.ti.com">microcontroller.ti.com</a> | Security            | <a href="http://www.ti.com/security">www.ti.com/security</a>             |
| Low Power<br>Wireless | <a href="http://www.ti.com/lpw">www.ti.com/lpw</a>                 | Telephony           | <a href="http://www.ti.com/telephony">www.ti.com/telephony</a>           |
|                       |  | Video & Imaging     | <a href="http://www.ti.com/video">www.ti.com/video</a>                   |
|                       |  | Wireless            | <a href="http://www.ti.com/wireless">www.ti.com/wireless</a>             |

Mailing Address: Texas Instruments, Post Office Box 655303, Dallas, Texas 75265  
Copyright © 2007, Texas Instruments Incorporated

**PACKAGING INFORMATION**

| Orderable Device | Status <sup>(1)</sup> | Package Type | Package Drawing | Pins | Package Qty | Eco Plan <sup>(2)</sup> | Lead/Ball Finish | MSL Peak Temp <sup>(3)</sup> |
|------------------|-----------------------|--------------|-----------------|------|-------------|-------------------------|------------------|------------------------------|
| 5962-9681601Q2A  | ACTIVE                | LCCC         | FK              | 20   | 1           | TBD                     | POST-PLATE       | N / A for Pkg Type           |
| 5962-9681601QCA  | ACTIVE                | CDIP         | J               | 14   | 1           | TBD                     | A42 SNPB         | N / A for Pkg Type           |
| 5962-9681601QDA  | ACTIVE                | CFP          | W               | 14   | 1           | TBD                     | A42              | N / A for Pkg Type           |
| SN74AHC86D       | ACTIVE                | SOIC         | D               | 14   | 50          | Green (RoHS & no Sb/Br) | CU NIPDAU        | Level-1-260C-UNLIM           |
| SN74AHC86DBLE    | OBSOLETE              | SSOP         | DB              | 14   |             | TBD                     | Call TI          | Call TI                      |
| SN74AHC86DBR     | ACTIVE                | SSOP         | DB              | 14   | 2000        | Green (RoHS & no Sb/Br) | CU NIPDAU        | Level-1-260C-UNLIM           |
| SN74AHC86DBRE4   | ACTIVE                | SSOP         | DB              | 14   | 2000        | Green (RoHS & no Sb/Br) | CU NIPDAU        | Level-1-260C-UNLIM           |
| SN74AHC86DBRG4   | ACTIVE                | SSOP         | DB              | 14   | 2000        | Green (RoHS & no Sb/Br) | CU NIPDAU        | Level-1-260C-UNLIM           |
| SN74AHC86DE4     | ACTIVE                | SOIC         | D               | 14   | 50          | Green (RoHS & no Sb/Br) | CU NIPDAU        | Level-1-260C-UNLIM           |
| SN74AHC86DG4     | ACTIVE                | SOIC         | D               | 14   | 50          | Green (RoHS & no Sb/Br) | CU NIPDAU        | Level-1-260C-UNLIM           |
| SN74AHC86DGVR    | ACTIVE                | TVSOP        | DGV             | 14   | 2000        | Green (RoHS & no Sb/Br) | CU NIPDAU        | Level-1-260C-UNLIM           |
| SN74AHC86DGVRE4  | ACTIVE                | TVSOP        | DGV             | 14   | 2000        | Green (RoHS & no Sb/Br) | CU NIPDAU        | Level-1-260C-UNLIM           |
| SN74AHC86DGVRG4  | ACTIVE                | TVSOP        | DGV             | 14   | 2000        | Green (RoHS & no Sb/Br) | CU NIPDAU        | Level-1-260C-UNLIM           |
| SN74AHC86DR      | ACTIVE                | SOIC         | D               | 14   | 2500        | Green (RoHS & no Sb/Br) | CU NIPDAU        | Level-1-260C-UNLIM           |
| SN74AHC86DRE4    | ACTIVE                | SOIC         | D               | 14   | 2500        | Green (RoHS & no Sb/Br) | CU NIPDAU        | Level-1-260C-UNLIM           |
| SN74AHC86DRG4    | ACTIVE                | SOIC         | D               | 14   | 2500        | Green (RoHS & no Sb/Br) | CU NIPDAU        | Level-1-260C-UNLIM           |
| SN74AHC86N       | ACTIVE                | PDIP         | N               | 14   | 25          | Pb-Free (RoHS)          | CU NIPDAU        | N / A for Pkg Type           |
| SN74AHC86NE4     | ACTIVE                | PDIP         | N               | 14   | 25          | Pb-Free (RoHS)          | CU NIPDAU        | N / A for Pkg Type           |
| SN74AHC86NSR     | ACTIVE                | SO           | NS              | 14   | 2000        | Green (RoHS & no Sb/Br) | CU NIPDAU        | Level-1-260C-UNLIM           |
| SN74AHC86NSRE4   | ACTIVE                | SO           | NS              | 14   | 2000        | Green (RoHS & no Sb/Br) | CU NIPDAU        | Level-1-260C-UNLIM           |
| SN74AHC86NSRG4   | ACTIVE                | SO           | NS              | 14   | 2000        | Green (RoHS & no Sb/Br) | CU NIPDAU        | Level-1-260C-UNLIM           |
| SN74AHC86PW      | ACTIVE                | TSSOP        | PW              | 14   | 90          | Green (RoHS & no Sb/Br) | CU NIPDAU        | Level-1-260C-UNLIM           |
| SN74AHC86PWE4    | ACTIVE                | TSSOP        | PW              | 14   | 90          | Green (RoHS & no Sb/Br) | CU NIPDAU        | Level-1-260C-UNLIM           |
| SN74AHC86PWG4    | ACTIVE                | TSSOP        | PW              | 14   | 90          | Green (RoHS & no Sb/Br) | CU NIPDAU        | Level-1-260C-UNLIM           |
| SN74AHC86PWLE    | OBSOLETE              | TSSOP        | PW              | 14   |             | TBD                     | Call TI          | Call TI                      |
| SN74AHC86PWR     | ACTIVE                | TSSOP        | PW              | 14   | 2000        | Green (RoHS & no Sb/Br) | CU NIPDAU        | Level-1-260C-UNLIM           |
| SN74AHC86PWRE4   | ACTIVE                | TSSOP        | PW              | 14   | 2000        | Green (RoHS & no Sb/Br) | CU NIPDAU        | Level-1-260C-UNLIM           |

| Orderable Device | Status <sup>(1)</sup> | Package Type | Package Drawing | Pins | Package Qty | Eco Plan <sup>(2)</sup> | Lead/Ball Finish | MSL Peak Temp <sup>(3)</sup> |
|------------------|-----------------------|--------------|-----------------|------|-------------|-------------------------|------------------|------------------------------|
| SN74AHC86PWRG4   | ACTIVE                | TSSOP        | PW              | 14   | 2000        | Green (RoHS & no Sb/Br) | CU NIPDAU        | Level-1-260C-UNLIM           |
| SN74AHC86RGYR    | ACTIVE                | QFN          | RGY             | 14   | 1000        | Green (RoHS & no Sb/Br) | CU NIPDAU        | Level-2-260C-1 YEAR          |
| SN74AHC86RGYRG4  | ACTIVE                | QFN          | RGY             | 14   | 1000        | Green (RoHS & no Sb/Br) | CU NIPDAU        | Level-2-260C-1 YEAR          |
| SNJ54AHC86FK     | ACTIVE                | LCCC         | FK              | 20   | 1           | TBD                     | POST-PLATE       | N / A for Pkg Type           |
| SNJ54AHC86J      | ACTIVE                | CDIP         | J               | 14   | 1           | TBD                     | A42 SNPB         | N / A for Pkg Type           |
| SNJ54AHC86W      | ACTIVE                | CFP          | W               | 14   | 1           | TBD                     | A42              | N / A for Pkg Type           |

<sup>(1)</sup> The marketing status values are defined as follows:

**ACTIVE:** Product device recommended for new designs.

**LIFEBUY:** TI has announced that the device will be discontinued, and a lifetime-buy period is in effect.

**NRND:** Not recommended for new designs. Device is in production to support existing customers, but TI does not recommend using this part in a new design.

**PREVIEW:** Device has been announced but is not in production. Samples may or may not be available.

**OBsolete:** TI has discontinued the production of the device.

<sup>(2)</sup> Eco Plan - The planned eco-friendly classification: Pb-Free (RoHS), Pb-Free (RoHS Exempt), or Green (RoHS & no Sb/Br) - please check <http://www.ti.com/productcontent> for the latest availability information and additional product content details.

**TBD:** The Pb-Free/Green conversion plan has not been defined.

**Pb-Free (RoHS):** TI's terms "Lead-Free" or "Pb-Free" mean semiconductor products that are compatible with the current RoHS requirements for all 6 substances, including the requirement that lead not exceed 0.1% by weight in homogeneous materials. Where designed to be soldered at high temperatures, TI Pb-Free products are suitable for use in specified lead-free processes.

**Pb-Free (RoHS Exempt):** This component has a RoHS exemption for either 1) lead-based flip-chip solder bumps used between the die and package, or 2) lead-based die adhesive used between the die and leadframe. The component is otherwise considered Pb-Free (RoHS compatible) as defined above.

**Green (RoHS & no Sb/Br):** TI defines "Green" to mean Pb-Free (RoHS compatible), and free of Bromine (Br) and Antimony (Sb) based flame retardants (Br or Sb do not exceed 0.1% by weight in homogeneous material)

<sup>(3)</sup> MSL, Peak Temp. -- The Moisture Sensitivity Level rating according to the JEDEC industry standard classifications, and peak solder temperature.

**Important Information and Disclaimer:** The information provided on this page represents TI's knowledge and belief as of the date that it is provided. TI bases its knowledge and belief on information provided by third parties, and makes no representation or warranty as to the accuracy of such information. Efforts are underway to better integrate information from third parties. TI has taken and continues to take reasonable steps to provide representative and accurate information but may not have conducted destructive testing or chemical analysis on incoming materials and chemicals. TI and TI suppliers consider certain information to be proprietary, and thus CAS numbers and other limited information may not be available for release.

In no event shall TI's liability arising out of such information exceed the total purchase price of the TI part(s) at issue in this document sold by TI to Customer on an annual basis.



**TAPE AND REEL INFORMATION**



**QUADRANT ASSIGNMENTS FOR PIN 1 ORIENTATION IN TAPE**



\*All dimensions are nominal

| Device        | Package Type | Package Drawing | Pins | SPQ  | Reel Diameter (mm) | Reel Width W1 (mm) | A0 (mm) | B0 (mm) | K0 (mm) | P1 (mm) | W (mm) | Pin1 Quadrant |
|---------------|--------------|-----------------|------|------|--------------------|--------------------|---------|---------|---------|---------|--------|---------------|
| SN74AHC86DBR  | SSOP         | DB              | 14   | 2000 | 330.0              | 16.4               | 8.2     | 6.6     | 2.5     | 12.0    | 16.0   | Q1            |
| SN74AHC86DGVR | TVSOP        | DGV             | 14   | 2000 | 330.0              | 12.4               | 6.8     | 4.0     | 1.6     | 8.0     | 12.0   | Q1            |
| SN74AHC86DR   | SOIC         | D               | 14   | 2500 | 330.0              | 16.4               | 6.5     | 9.0     | 2.1     | 8.0     | 16.0   | Q1            |
| SN74AHC86NSR  | SO           | NS              | 14   | 2000 | 330.0              | 16.4               | 8.2     | 10.5    | 2.5     | 12.0    | 16.0   | Q1            |
| SN74AHC86PWR  | TSSOP        | PW              | 14   | 2000 | 330.0              | 12.4               | 7.0     | 5.6     | 1.6     | 8.0     | 12.0   | Q1            |
| SN74AHC86RGYR | QFN          | RGY             | 14   | 1000 | 180.0              | 12.4               | 3.85    | 3.85    | 1.35    | 8.0     | 12.0   | Q1            |

**TAPE AND REEL BOX DIMENSIONS**



\*All dimensions are nominal

| Device        | Package Type | Package Drawing | Pins | SPQ  | Length (mm) | Width (mm) | Height (mm) |
|---------------|--------------|-----------------|------|------|-------------|------------|-------------|
| SN74AHC86DBR  | SSOP         | DB              | 14   | 2000 | 346.0       | 346.0      | 33.0        |
| SN74AHC86DGVR | TVSOP        | DGV             | 14   | 2000 | 346.0       | 346.0      | 29.0        |
| SN74AHC86DR   | SOIC         | D               | 14   | 2500 | 346.0       | 346.0      | 33.0        |
| SN74AHC86NSR  | SO           | NS              | 14   | 2000 | 346.0       | 346.0      | 33.0        |
| SN74AHC86PWR  | TSSOP        | PW              | 14   | 2000 | 346.0       | 346.0      | 29.0        |
| SN74AHC86RGYR | QFN          | RGY             | 14   | 1000 | 190.5       | 212.7      | 31.8        |

DB (R-PDSO-G\*\*)

PLASTIC SMALL-OUTLINE

28 PINS SHOWN



- NOTES: A. All linear dimensions are in millimeters.  
 B. This drawing is subject to change without notice.  
 C. Body dimensions do not include mold flash or protrusion not to exceed 0,15.  
 D. Falls within JEDEC MO-150

# MECHANICAL DATA

NS (R-PDSO-G\*\*)

PLASTIC SMALL-OUTLINE PACKAGE

14-PINS SHOWN



- NOTES:
- A. All linear dimensions are in millimeters.
  - B. This drawing is subject to change without notice.
  - C. Body dimensions do not include mold flash or protrusion, not to exceed 0,15.

# J (R-GDIP-T\*\*)

14 LEADS SHOWN

# CERAMIC DUAL IN-LINE PACKAGE



| DIM \ PINS ** | 14                     | 16                     | 18                     | 20                     |
|---------------|------------------------|------------------------|------------------------|------------------------|
| A             | 0.300<br>(7,62)<br>BSC | 0.300<br>(7,62)<br>BSC | 0.300<br>(7,62)<br>BSC | 0.300<br>(7,62)<br>BSC |
| B MAX         | 0.785<br>(19,94)       | .840<br>(21,34)        | 0.960<br>(24,38)       | 1.060<br>(26,92)       |
| B MIN         | —                      | —                      | —                      | —                      |
| C MAX         | 0.300<br>(7,62)        | 0.300<br>(7,62)        | 0.310<br>(7,87)        | 0.300<br>(7,62)        |
| C MIN         | 0.245<br>(6,22)        | 0.245<br>(6,22)        | 0.220<br>(5,59)        | 0.245<br>(6,22)        |



4040083/F 03/03

- NOTES:
- All linear dimensions are in inches (millimeters).
  - This drawing is subject to change without notice.
  - This package is hermetically sealed with a ceramic lid using glass frit.
  - Index point is provided on cap for terminal identification only on press ceramic glass frit seal only.
  - Falls within MIL STD 1835 GDIP1-T14, GDIP1-T16, GDIP1-T18 and GDIP1-T20.

FK (S-CQCC-N\*\*)

LEADLESS CERAMIC CHIP CARRIER

28 TERMINAL SHOWN



- NOTES:
- A. All linear dimensions are in inches (millimeters).
  - B. This drawing is subject to change without notice.
  - C. This package can be hermetically sealed with a metal lid.
  - D. The terminals are gold plated.
  - E. Falls within JEDEC MS-004

PW (R-PDSO-G\*\*)

PLASTIC SMALL-OUTLINE PACKAGE

14 PINS SHOWN



4040064/F 01/97

- NOTES: A. All linear dimensions are in millimeters.  
 B. This drawing is subject to change without notice.  
 C. Body dimensions do not include mold flash or protrusion not to exceed 0,15.  
 D. Falls within JEDEC MO-153

D (R-PDSO-G14)

PLASTIC SMALL-OUTLINE PACKAGE



4040047-3/H 11/2006

- NOTES:
- A. All linear dimensions are in inches (millimeters).
  - B. This drawing is subject to change without notice.
  - $\triangle C$  Body length does not include mold flash, protrusions, or gate burrs. Mold flash, protrusions, or gate burrs shall not exceed .006 (0,15) per end.
  - $\triangle D$  Body width does not include interlead flash. Interlead flash shall not exceed .017 (0,43) per side.
  - E. Reference JEDEC MS-012 variation AB.



DGV (R-PDSO-G\*\*)

PLASTIC SMALL-OUTLINE

24 PINS SHOWN



4073251/E 08/00



- NOTES: A. All linear dimensions are in millimeters.  
 B. This drawing is subject to change without notice.  
 C. Body dimensions do not include mold flash or protrusion, not to exceed 0,15 per side.  
 D. Falls within JEDEC: 24/48 Pins – MO-153  
 14/16/20/56 Pins – MO-194

RGY (S-PQFP-N14)

PLASTIC QUAD FLATPACK



4203539-2/G 04/2005

- NOTES:
- A. All linear dimensions are in millimeters. Dimensioning and tolerancing per ASME Y14.5M-1994.
  - B. This drawing is subject to change without notice.
  - C. QFN (Quad Flatpack No-Lead) package configuration.
  -  The package thermal pad must be soldered to the board for thermal and mechanical performance.
  -  Pin 1 identifiers are located on both top and bottom of the package and within the zone indicated. The Pin 1 identifiers are either a molded, marked, or metal feature.
  - F. Package complies to JEDEC MO-241 variation BA.

THERMAL INFORMATION

This package incorporates an exposed thermal pad that is designed to be attached directly to an external heatsink. The thermal pad must be soldered directly to the printed circuit board (PCB). After soldering, the PCB can be used as a heatsink. In addition, through the use of thermal vias, the thermal pad can be attached directly to the appropriate copper plane shown in the electrical schematic for the device, or alternatively, can be attached to a special heatsink structure designed into the PCB. This design optimizes the heat transfer from the integrated circuit (IC).

For information on the Quad Flatpack No-Lead (QFN) package and its advantages, refer to Application Report, Quad Flatpack No-Lead Logic Packages, Texas Instruments Literature No. SCBA017. This document is available at [www.ti.com](http://www.ti.com).

The exposed thermal pad dimensions for this package are shown in the following illustration.

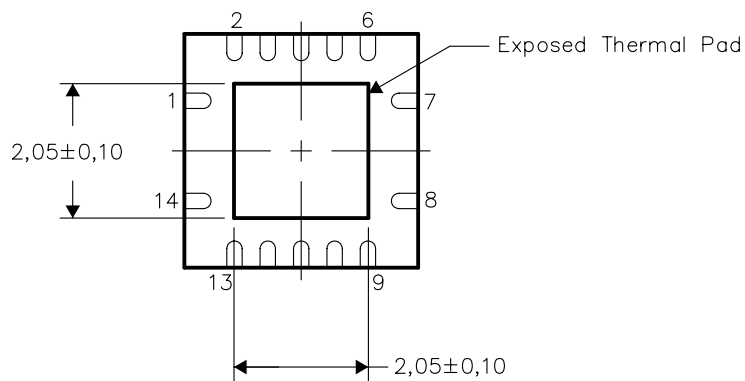

Bottom View

NOTE: All linear dimensions are in millimeters

Exposed Thermal Pad Dimensions

RGY (R-PQFP-N14)

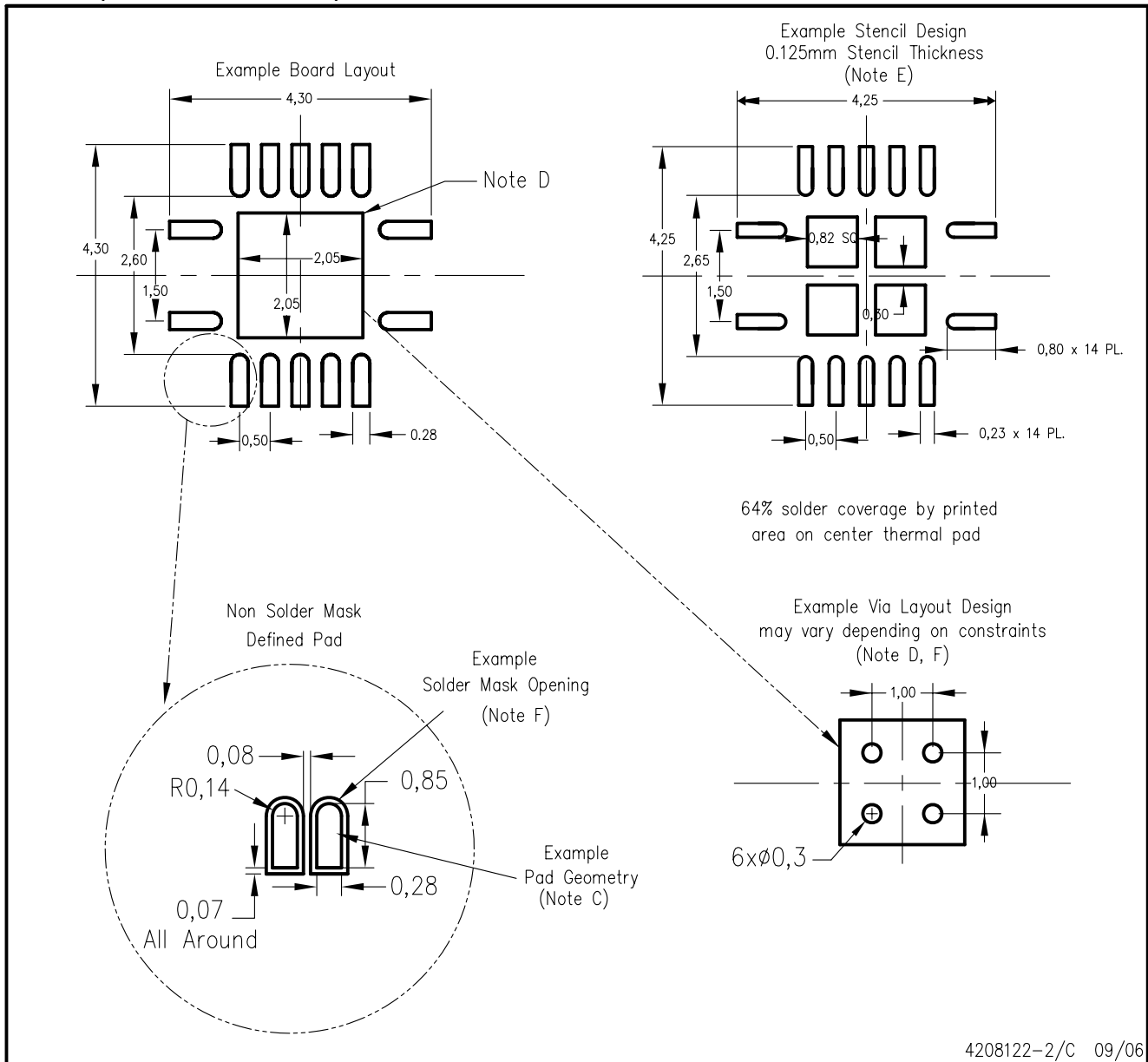

- NOTES:
- A. All linear dimensions are in millimeters.
  - B. This drawing is subject to change without notice.
  - C. Publication IPC-7351 is recommended for alternate designs.
  - D. This package is designed to be soldered to a thermal pad on the board. Refer to Application Note, Quad Flat-Pack Packages, Texas Instruments Literature No. SCBA017, SLUA271, and also the Product Data Sheets for specific thermal information, via requirements, and recommended board layout. These documents are available at [www.ti.com](http://www.ti.com) <<http://www.ti.com>>.
  - E. Laser cutting apertures with trapezoidal walls and also rounding corners will offer better paste release. Customers should contact their board assembly site for stencil design recommendations. Refer to IPC 7525 for stencil design considerations.
  - F. Customers should contact their board fabrication site for minimum solder mask web tolerances between signal pads.

W (R-GDFP-F14)

CERAMIC DUAL FLATPACK



- NOTES:
- A. All linear dimensions are in inches (millimeters).
  - B. This drawing is subject to change without notice.
  - C. This package can be hermetically sealed with a ceramic lid using glass frit.
  - D. Index point is provided on cap for terminal identification only.
  - E. Falls within MIL STD 1835 GDFP1-F14 and JEDEC MO-092AB

N (R-PDIP-T\*\*)

PLASTIC DUAL-IN-LINE PACKAGE

16 PINS SHOWN



- NOTES:
- A. All linear dimensions are in inches (millimeters).
  - B. This drawing is subject to change without notice.
  - Falls within JEDEC MS-001, except 18 and 20 pin minimum body length (Dim A).
  - The 20 pin end lead shoulder width is a vendor option, either half or full width.

## IMPORTANT NOTICE

Texas Instruments Incorporated and its subsidiaries (TI) reserve the right to make corrections, modifications, enhancements, improvements, and other changes to its products and services at any time and to discontinue any product or service without notice. Customers should obtain the latest relevant information before placing orders and should verify that such information is current and complete. All products are sold subject to TI's terms and conditions of sale supplied at the time of order acknowledgment.

TI warrants performance of its hardware products to the specifications applicable at the time of sale in accordance with TI's standard warranty. Testing and other quality control techniques are used to the extent TI deems necessary to support this warranty. Except where mandated by government requirements, testing of all parameters of each product is not necessarily performed.

TI assumes no liability for applications assistance or customer product design. Customers are responsible for their products and applications using TI components. To minimize the risks associated with customer products and applications, customers should provide adequate design and operating safeguards.

TI does not warrant or represent that any license, either express or implied, is granted under any TI patent right, copyright, mask work right, or other TI intellectual property right relating to any combination, machine, or process in which TI products or services are used. Information published by TI regarding third-party products or services does not constitute a license from TI to use such products or services or a warranty or endorsement thereof. Use of such information may require a license from a third party under the patents or other intellectual property of the third party, or a license from TI under the patents or other intellectual property of TI.

Reproduction of TI information in TI data books or data sheets is permissible only if reproduction is without alteration and is accompanied by all associated warranties, conditions, limitations, and notices. Reproduction of this information with alteration is an unfair and deceptive business practice. TI is not responsible or liable for such altered documentation. Information of third parties may be subject to additional restrictions.

Resale of TI products or services with statements different from or beyond the parameters stated by TI for that product or service voids all express and any implied warranties for the associated TI product or service and is an unfair and deceptive business practice. TI is not responsible or liable for any such statements.

TI products are not authorized for use in safety-critical applications (such as life support) where a failure of the TI product would reasonably be expected to cause severe personal injury or death, unless officers of the parties have executed an agreement specifically governing such use. Buyers represent that they have all necessary expertise in the safety and regulatory ramifications of their applications, and acknowledge and agree that they are solely responsible for all legal, regulatory and safety-related requirements concerning their products and any use of TI products in such safety-critical applications, notwithstanding any applications-related information or support that may be provided by TI. Further, Buyers must fully indemnify TI and its representatives against any damages arising out of the use of TI products in such safety-critical applications.

TI products are neither designed nor intended for use in military/aerospace applications or environments unless the TI products are specifically designated by TI as military-grade or "enhanced plastic." Only products designated by TI as military-grade meet military specifications. Buyers acknowledge and agree that any such use of TI products which TI has not designated as military-grade is solely at the Buyer's risk, and that they are solely responsible for compliance with all legal and regulatory requirements in connection with such use.

TI products are neither designed nor intended for use in automotive applications or environments unless the specific TI products are designated by TI as compliant with ISO/TS 16949 requirements. Buyers acknowledge and agree that, if they use any non-designated products in automotive applications, TI will not be responsible for any failure to meet such requirements.

Following are URLs where you can obtain information on other Texas Instruments products and application solutions:

### Products

|                             |  |
|-----------------------------|--|
| Amplifiers                  | <a href="http://amplifier.ti.com">amplifier.ti.com</a>             |
| Data Converters             | <a href="http://dataconverter.ti.com">dataconverter.ti.com</a>     |
| DSP                         | <a href="http://dsp.ti.com">dsp.ti.com</a>                         |
| Clocks and Timers           | <a href="http://www.ti.com/clocks">www.ti.com/clocks</a>           |
| Interface                   | <a href="http://interface.ti.com">interface.ti.com</a>             |
| Logic                       | <a href="http://logic.ti.com">logic.ti.com</a>                     |
| Power Mgmt                  | <a href="http://power.ti.com">power.ti.com</a>                     |
| Microcontrollers            | <a href="http://microcontroller.ti.com">microcontroller.ti.com</a> |
| RFID                        | <a href="http://www.ti-rfid.com">www.ti-rfid.com</a>               |
| RF/IF and ZigBee® Solutions | <a href="http://www.ti.com/lprf">www.ti.com/lprf</a>               |

### Applications

|                    |  |
|--------------------|--|
| Audio              | <a href="http://www.ti.com/audio">www.ti.com/audio</a>                   |
| Automotive         | <a href="http://www.ti.com/automotive">www.ti.com/automotive</a>         |
| Broadband          | <a href="http://www.ti.com/broadband">www.ti.com/broadband</a>           |
| Digital Control    | <a href="http://www.ti.com/digitalcontrol">www.ti.com/digitalcontrol</a> |
| Medical            | <a href="http://www.ti.com/medical">www.ti.com/medical</a>               |
| Military           | <a href="http://www.ti.com/military">www.ti.com/military</a>             |
| Optical Networking | <a href="http://www.ti.com/opticalnetwork">www.ti.com/opticalnetwork</a> |
| Security           | <a href="http://www.ti.com/security">www.ti.com/security</a>             |
| Telephony          | <a href="http://www.ti.com/telephony">www.ti.com/telephony</a>           |
| Video & Imaging    | <a href="http://www.ti.com/video">www.ti.com/video</a>                   |
| Wireless           | <a href="http://www.ti.com/wireless">www.ti.com/wireless</a>             |

Mailing Address: Texas Instruments, Post Office Box 655303, Dallas, Texas 75265  
Copyright © 2008, Texas Instruments Incorporated