

RoHS  **224/225 Series** Lead-Free 2AG, Fast-Acting



Description

The 2AG Fast-Acting Fuses are available in cartridge form or with axial leads. 2AG Fuses provide the same performance characteristics as their 3AG counterpart, while occupying one-third the space. Sleeved fuses are available.





Features

- In accordance with underwriter's Laboratories Standard UL 248-14
- Available in cartridge and axial lead form and with various forming dimensions
- RoHS compliant and Lead-free

Applications

Used as supplementary protection in appliance or utilization equipment to provide individual protection for components or internal circuits.





Agency Approvals

Agency	Agency File Number	Ampere Range
	E10480	100mA - 3.5A
	E10480	4A - 10A
	LR 29862	100mA - 10A
	NBK200405-E10480 NBK060405-E10480	Cartridge: 1A - 10A Pigtail: 1A - 10A
		100mA - 10A

Electrical Characteristics for Series

% of Ampere Rating	Opening Time
100%	4 hours, Minimum
135%	1 hour, Maximum
200%	1 sec., Maximum

Electrical Characteristic Specifications by Item

Amp Code	Ampere Rating (A)	Voltage Rating (V)	Interrupting Rating	Nominal Cold Resistance (Ohms)	Nominal Melting I ² t (A ² sec)	Agency Approvals				
										
.100	.1	250	35A@250Vac 10KA@125Vac 10KA@125Vdc	6.1500	0.00075	x		x		x
.125	0.125	250		3.9000	0.00286	x		x		x
.250	0.25	250		1.1500	0.0300	x		x		x
.375	0.375	250		0.3950	0.171	x		x		x
.500	0.5	250		0.2650	0.365	x		x		x
.750	0.75	250		0.1520	1.050	x		x		x
001.	1	250		0.1027	2.220	x		x	x	x
01.5	1.5	250	0.0712	0.800	x		x	x	x	
002.	2	250	0.0497	1.500	x		x	x	x	
02.5	2.5	250	0.0372	2.680	x		x	x	x	
003.	3	250	0.0317	4.620	x		x	x	x	
03.5	3.5	250	0.0265	6.700	x		x	x	x	
004.	4	125	100A@250Vac 500A@125Vac	0.0240	9.400		x	x	x	x
005.	5	125		0.0186	17.0		x	x	x	x
005.	5	250		0.0186	17.0		x	x		x
006.	6	125	500A@125Vac	0.0154	22.1		x	x	x	x
007.	7	125		0.0130	40.0		x	x	x	x
008.	8	125		0.0107	56.0		x	x	x	x
010.	10	125		0.0075	116.0		x	x	x	x

* 10A with 500A @ 125 Vdc internal breaking capacity testing.

Temperature Derating Curve

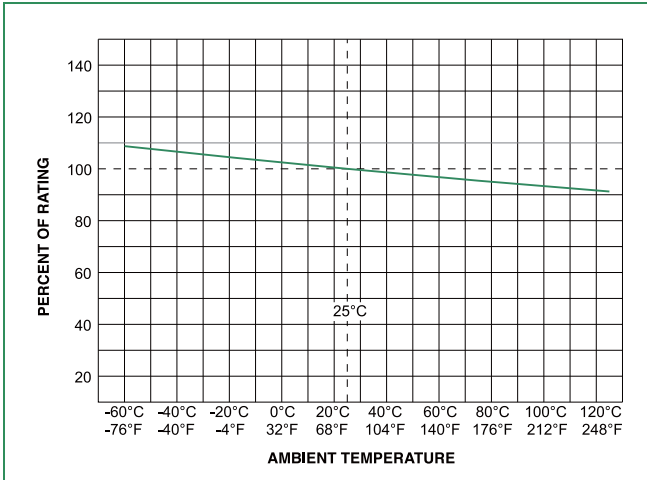

Average Time Current Curves

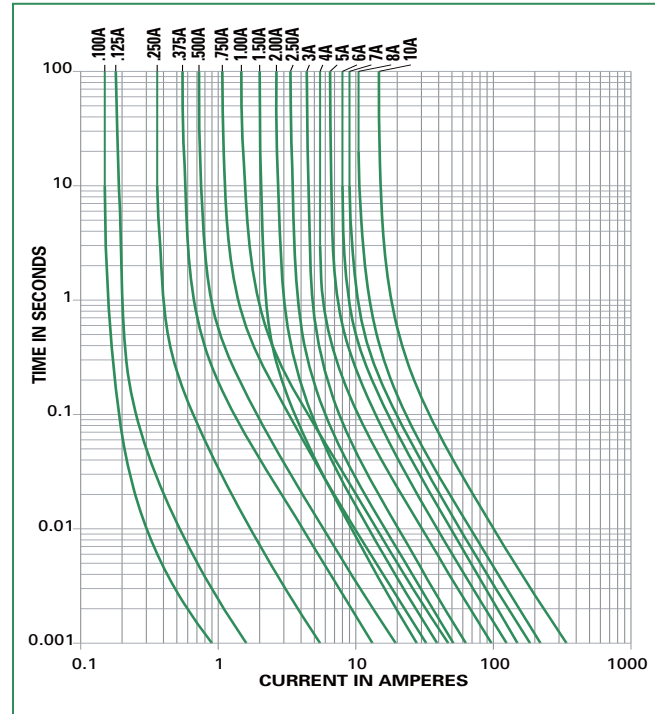

Soldering Parameters - Wave Soldering

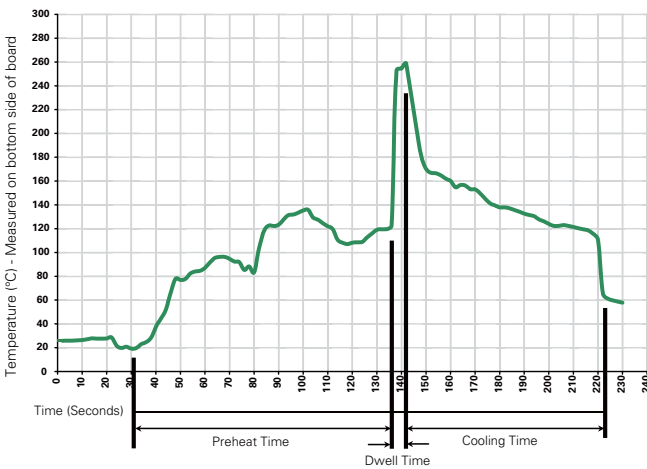

Recommended Process Parameters:

Wave Parameter	Lead-Free Recommendation
Preheat: (Depends on Flux Activation Temperature) (Typical Industry Recommendation)	
Temperature Minimum:	100° C
Temperature Maximum:	150° C
Preheat Time:	60-180 seconds
Solder Pot Temperature:	260° C Maximum
Solder Dwell Time:	2-5 seconds

Recommended Hand-Solder Parameters:

Solder Iron Temperature: 350° C +/- 5° C
 Heating Time: 5 seconds max.

Note: These devices are not recommended for IR or Convection Reflow process.

Product Characteristics

Materials	Body : Glass Cap : Nickel-plated brass Leads: Tin-plated Copper
Terminal Strength	MIL-STD-202F Method 211A, Test Condition A
Solderability	Reference IEC 6012/Second Edition 2003-01 Annex A
Product Marking	Cap1 : Brand logo, current and Voltage Ratings Cap2 : Series and Agency approval Mark

Operating Temperature:	-55°C to +125°C
Thermal Shock:	MIL-STD-202F, Method 107G, Test Condition B (5 Cycles -65°C to +125°C).
Vibration	MIL-STD-202F, Method 201A
Humidity	MIL-STD-202F Method 103B, Test Condition A: High RH (95%) and elevated temp (40°C) for 240 hours
Salt Spray	MIL-STD-202F Method 101D, Test Condition B

Dimensions

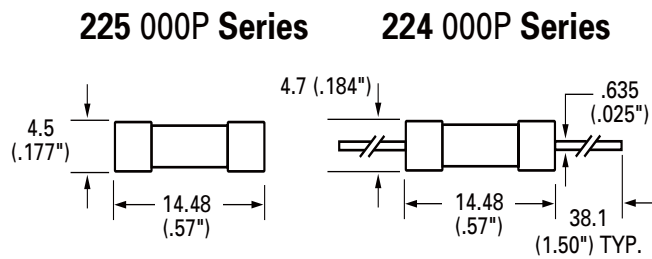

Part Numbering System

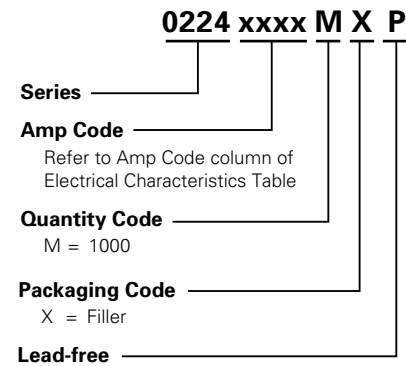

Packaging

Packaging Option	Packaging Specification	Quantity	Quantity & Packaging Code	Taping Width
224 Series				
Bulk	N/A	1000	MX	N/A
Bulk	N/A	100	HX	N/A
Reel and Tape	EIA 296-E	1500	DRT1	T1=52mm (2.062")
225 Series				
Bulk	N/A	1000	MX	N/A
Bulk	N/A	100	HX	N/A