

Standard Avalanche Sinterglass Diode

Features

- Controlled avalanche characteristics
- Glass passivated
- Low reverse current
- High surge current loading
- Hermetically sealed axial-leaded glass envelope

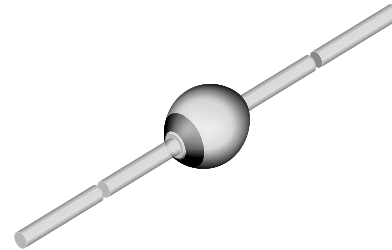

949539

Applications

Rectification diode, general purpose

Mechanical Data

Case: SOD-57 Sintered glass case

Terminals: Plated axial leads, solderable per MIL-STD-750, Method 2026

Polarity: Color band denotes cathode end

Mounting Position: Any

Weight: approx. 369 mg

Parts Table

Part	Type differentiation	Package
1N5059	$V_R = 200 \text{ V}; I_{FAV} = 2 \text{ A}$	SOD-57
1N5060	$V_R = 400 \text{ V}; I_{FAV} = 2 \text{ A}$	SOD-57
1N5061	$V_R = 600 \text{ V}; I_{FAV} = 2 \text{ A}$	SOD-57
1N5062	$V_R = 800 \text{ V}; I_{FAV} = 2 \text{ A}$	SOD-57

Absolute Maximum Ratings

$T_{amb} = 25 \text{ }^\circ\text{C}$, unless otherwise specified

Parameter	Test condition	Part	Symbol	Value	Unit
Reverse voltage = Repetitive peak reverse voltage	see electrical characteristics	1N5059	$V_R = V_{RRM}$	200	V
		1N5060	$V_R = V_{RRM}$	400	V
		1N5061	$V_R = V_{RRM}$	600	V
		1N5062	$V_R = V_{RRM}$	800	V
Peak forward surge current	$t_p = 10 \text{ ms}$, half-sinewave		I_{FSM}	50	A
Average forward current	$R_{thJA} = 45 \text{ K/W}$, $T_{amb} = 50 \text{ }^\circ\text{C}$		I_{FAV}	2	A
	$R_{thJA} = 100 \text{ K/W}$, $T_{amb} = 75 \text{ }^\circ\text{C}$		I_{FAV}	0.8	A
Junction and storage temperature range			$T_j = T_{stg}$	- 55 to + 175	$^\circ\text{C}$
Max. pulse energy in avalanche mode, non repetitive (inductive load switch off)	$I_{(BR)R} = 1 \text{ A}$, inductive load		E_R	20	mJ

Maximum Thermal Resistance

$T_{amb} = 25\text{ }^{\circ}\text{C}$, unless otherwise specified

Parameter	Test condition	Symbol	Value	Unit
Junction ambient	Lead length $l = 10\text{ mm}$, $T_L = \text{constant}$	R_{thJA}	45	K/W
	on PC board with spacing 25 mm	R_{thJA}	100	K/W

Electrical Characteristics

$T_{amb} = 25\text{ }^{\circ}\text{C}$, unless otherwise specified

Parameter	Test condition	Part	Symbol	Min	Typ.	Max	Unit
Forward voltage	$I_F = 1\text{ A}$		V_F			1	V
	$I_F = 2.5\text{ A}$		V_F			1.15	V
Reverse current	$V_R = V_{RRM}$		I_R			1	μA
	$V_R = V_{RRM}$, $T_J = 100\text{ }^{\circ}\text{C}$		I_R			10	μA
	$V_R = V_{RRM}$, $T_J = 150\text{ }^{\circ}\text{C}$		I_R			100	μA
Reverse breakdown voltage	$I_R = 100\text{ }\mu\text{A}$	1N5059	$V_{(BR)R}$	225		1600	V
		1N5060	$V_{(BR)R}$	450		1600	V
		1N5061	$V_{(BR)R}$	650		1600	V
		1N5062	$V_{(BR)R}$	900		1600	V
Reverse recovery time	$I_F = 0.5\text{ A}$, $I_R = 1\text{ A}$, $i_R = 0.25\text{ A}$		t_{rr}			4	μs
Diode capacitance	$V_R = 0\text{ V}$, $f = 1\text{ MHz}$		C_D		40		pF

Typical Characteristics ($T_{amb} = 25\text{ }^{\circ}\text{C}$ unless otherwise specified)

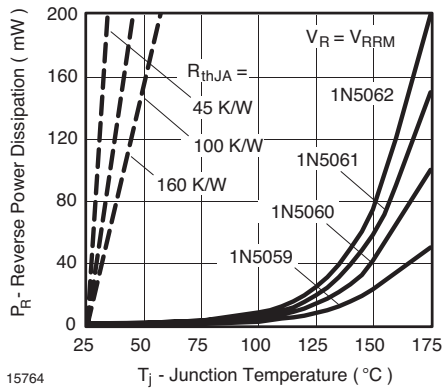

15764

Figure 1. Max. Reverse Power Dissipation vs. Junction Temperature

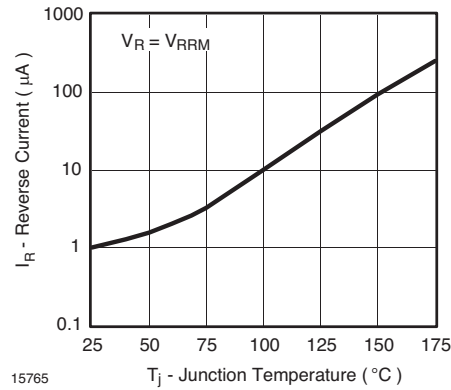

15765

Figure 2. Max. Reverse Current vs. Junction Temperature

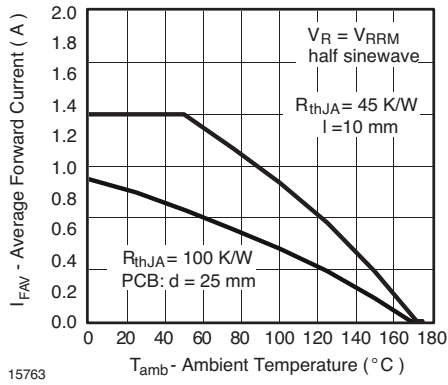

Figure 3. Max. Average Forward Current vs. Ambient Temperature

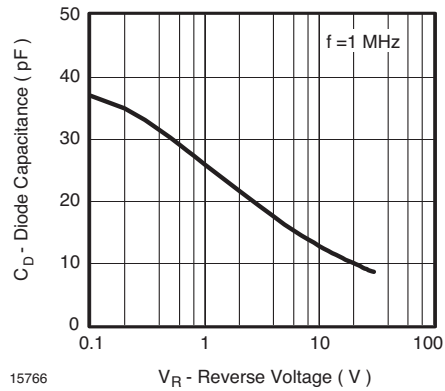

Figure 5. Typ. Diode Capacitance vs. Reverse Voltage

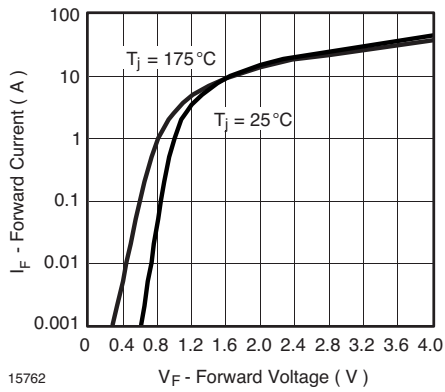
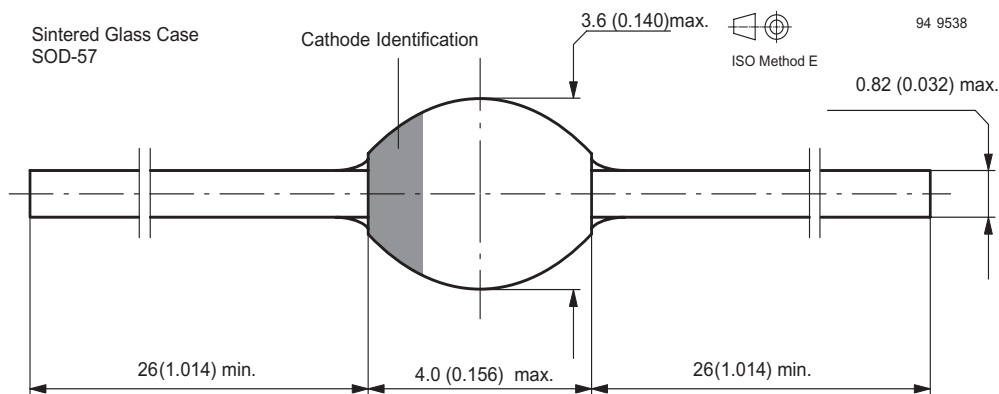

Figure 4. Max. Forward Current vs. Forward Voltage

Package Dimensions in mm (Inches)



Ozone Depleting Substances Policy Statement

It is the policy of **Vishay Semiconductor GmbH** to

1. Meet all present and future national and international statutory requirements.
2. Regularly and continuously improve the performance of our products, processes, distribution and operating systems with respect to their impact on the health and safety of our employees and the public, as well as their impact on the environment.

It is particular concern to control or eliminate releases of those substances into the atmosphere which are known as ozone depleting substances (ODSs).

The Montreal Protocol (1987) and its London Amendments (1990) intend to severely restrict the use of ODSs and forbid their use within the next ten years. Various national and international initiatives are pressing for an earlier ban on these substances.

Vishay Semiconductor GmbH has been able to use its policy of continuous improvements to eliminate the use of ODSs listed in the following documents.

1. Annex A, B and list of transitional substances of the Montreal Protocol and the London Amendments respectively
2. Class I and II ozone depleting substances in the Clean Air Act Amendments of 1990 by the Environmental Protection Agency (EPA) in the USA
3. Council Decision 88/540/EEC and 91/690/EEC Annex A, B and C (transitional substances) respectively.

Vishay Semiconductor GmbH can certify that our semiconductors are not manufactured with ozone depleting substances and do not contain such substances.

**We reserve the right to make changes to improve technical design
and may do so without further notice.**

Parameters can vary in different applications. All operating parameters must be validated for each customer application by the customer. Should the buyer use Vishay Semiconductors products for any unintended or unauthorized application, the buyer shall indemnify Vishay Semiconductors against all claims, costs, damages, and expenses, arising out of, directly or indirectly, any claim of personal damage, injury or death associated with such unintended or unauthorized use.

Vishay Semiconductor GmbH, P.O.B. 3535, D-74025 Heilbronn, Germany
Telephone: 49 (0)7131 67 2831, Fax number: 49 (0)7131 67 2423