

Distributed by:

JAMECO[®]
ELECTRONICS

www.Jameco.com ♦ 1-800-831-4242

The content and copyrights of the attached
material are the property of its owner.

Jameco Part Number 1589515

Features

- Guard Ring Die Construction for Transient Protection
- Ideally Suited for Automatic Assembly
- Low Power Loss, High Efficiency
- Surge Overload Rating to 50A Peak
- For Use in Low Voltage, High Frequency Inverters, Free Wheeling, and Polarity Protection Application
- High Temperature Soldering: 260°C/10 Second at Terminal
- Lead Free Finish/RoHS Compliant (Note 3)**

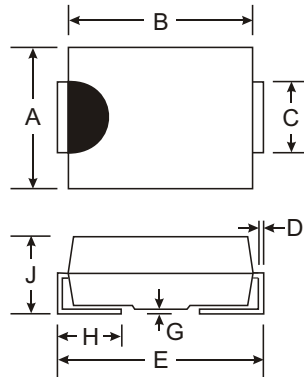

Dim	SMA		SMB	
	Min	Max	Min	Max
A	2.29	2.92	3.30	3.94
B	4.00	4.60	4.06	4.57
C	1.27	1.63	1.96	2.21
D	0.15	0.31	0.15	0.31
E	4.80	5.59	5.00	5.59
G	0.10	0.20	0.10	0.20
H	0.76	1.52	0.76	1.52
J	2.01	2.30	2.00	2.40
All Dimensions in mm				

Mechanical Data

- Case: SMA/SMB
- Case Material: Molded Plastic. UL Flammability Classification Rating 94V-0
- Moisture Sensitivity: Level 1 per J-STD-020C
- Terminals: Lead Free Plating (Matte Tin Finish).
- Solderable per MIL-STD-202, Method 208 **(e3)**
- Polarity: Cathode Band or Cathode Notch
- Marking Information: See Page 3
- Ordering Information: See Page 3
- Approximate Weight: SMA 0.064 grams
SMB 0.093 grams

No Suffix Designates SMB Package
"A" Suffix Designates SMA Package

Maximum Ratings and Electrical Characteristics @ T_A = 25°C unless otherwise specified

Single phase, half wave, 60Hz, resistive or inductive load.
For capacitive load, derate current by 20%.

Characteristic	Symbol	B220/A	B230/A	B240/A	B250/A	B260/A	Unit
Peak Repetitive Reverse Voltage Working Peak Reverse Voltage DC Blocking Voltage	V _{RRM} V _{RWM} V _R	20	30	40	50	60	V
RMS Reverse Voltage	V _{R(RMS)}	14	21	28	35	42	V
Average Rectified Output Current @ T _T = 100°C	I _O	2.0					A
Non-Repetitive Peak Forward Surge Current, 8.3ms single half sine-wave superimposed on rated load	I _{FSM}	50					A
Forward Voltage @ I _F = 2.0A	V _{FM}	0.50			0.70		V
Peak Reverse Current at Rated DC Blocking Voltage @ T _A = 25°C @ T _A = 100°C	I _{RM}	0.5 20					mA
Typical Total Capacitance (Note 2)	C _T	200					pF
Typical Thermal Resistance, Junction to Terminal	R _{JT}	20					°C/W
Typical Thermal Resistance, Junction to Ambient (Note 1)	R _{JA}	25					°C/W
Operating and Storage Temperature Range	T _J , T _{STG}	-65 to +150					°C

- Notes: 1. Thermal Resistance: Junction to terminal, unit mounted on PC board with 5.0 mm² (0.013 mm thick) copper pad as heat sink.
2. Measured at 1.0 MHz and applied reverse voltage of 4.0V DC.
3. RoHS revision 13.2.2003. High Temperature Solder Exemption Applied, see *EU Directive Annex Note 7*.

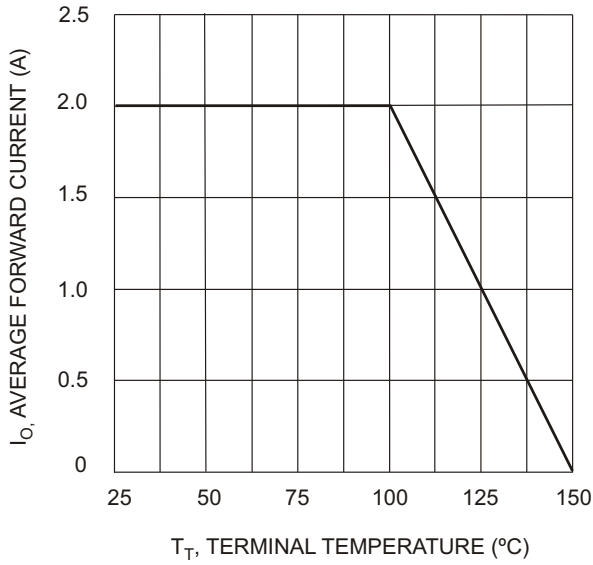

Fig. 1 Forward Current Derating Curve

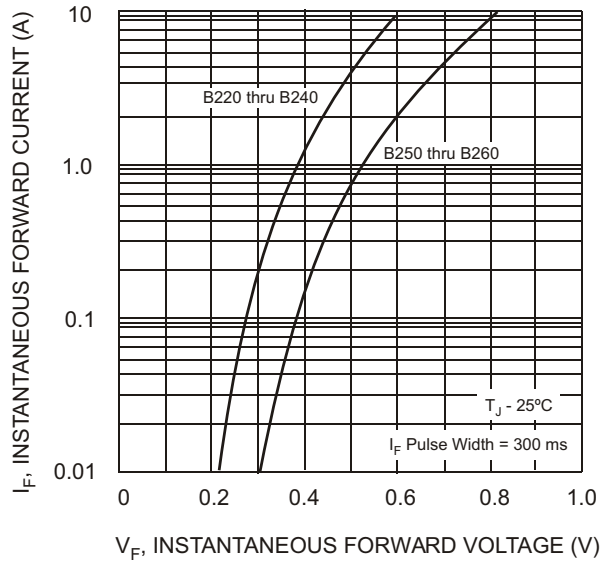

Fig. 2 Typical Forward Characteristics

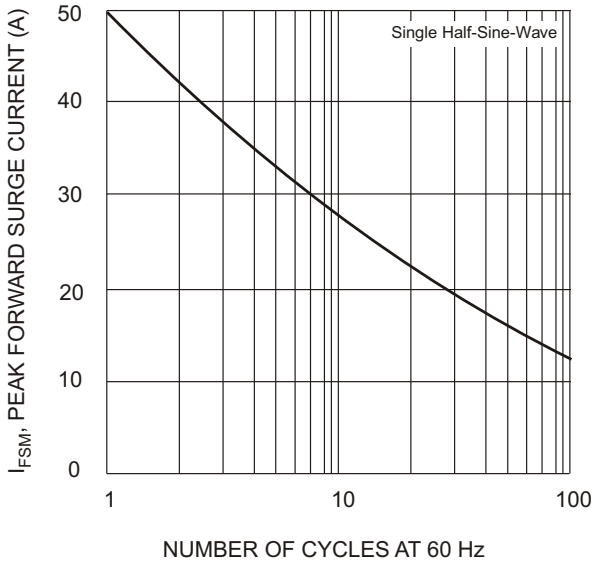

Fig. 3 Max Non-Repetitive Peak Forward Surge Current

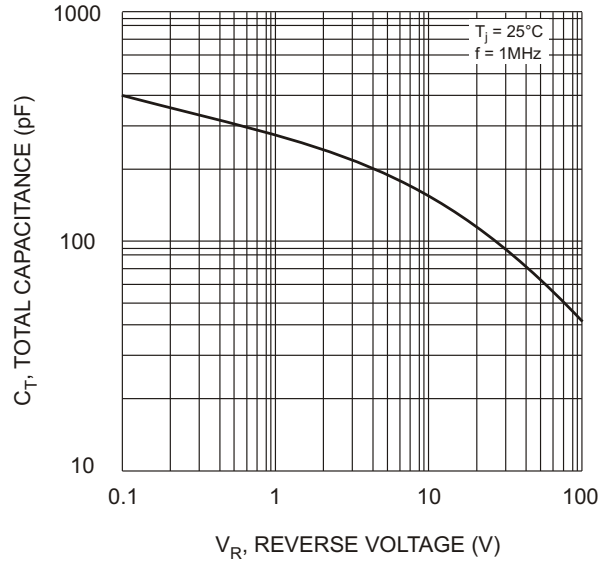

Fig. 4 Typical Total Capacitance

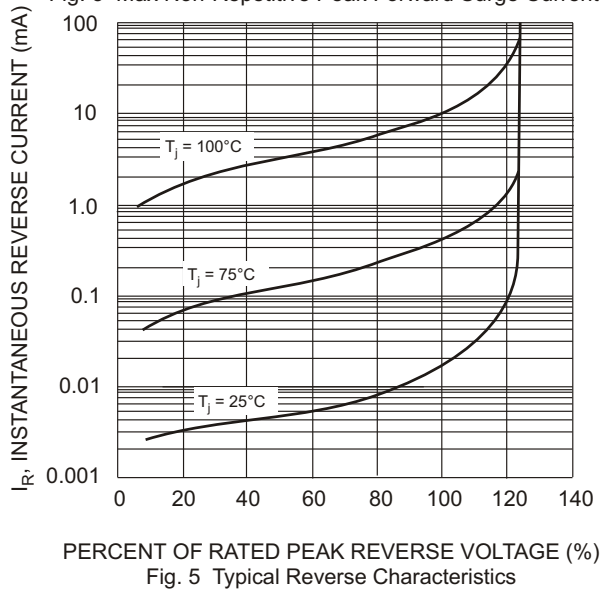

Fig. 5 Typical Reverse Characteristics

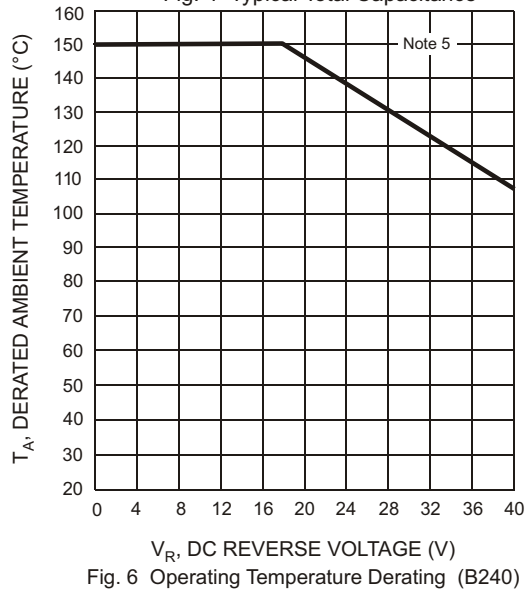

Fig. 6 Operating Temperature Derating (B240)

Ordering Information (Note 4)

Device*	Packaging	Shipping
B2xxA-13-F B2xx-13-F	SMA SMB	5000/Tape & Reel 3000/Tape & Reel

* x = Device type, e.g. B260A-13-F (SMA package); B240-13-F (SMB package).

- Notes:
4. For Packaging Details, go to our website at <http://www.diodes.com/datasheets/ap02007.pdf>.
 5. Device mounted on FR-4 PC board with minimum recommended pad layout pattern as per <http://www.diodes.com/datasheets/ap02001.pdf>.

Marking Information

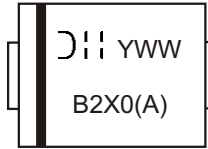

B2X0A = Product type marking code, ex: B220A (SMA package)
 B2X0 = Product type marking code, ex: B230 (SMB package)
 D|| = Manufacturers' code marking
 YWW = Date code marking
 Y = Last digit of year ex: 2 for 2002
 WW = Week code 01 to 52

IMPORTANT NOTICE

Diodes Incorporated and its subsidiaries reserve the right to make modifications, enhancements, improvements, corrections or other changes without further notice to any product herein. Diodes Incorporated does not assume any liability arising out of the application or use of any product described herein; neither does it convey any license under its patent rights, nor the rights of others. The user of products in such applications shall assume all risks of such use and will agree to hold Diodes Incorporated and all the companies whose products are represented on our website, harmless against all damages.

LIFE SUPPORT

Diodes Incorporated products are not authorized for use as critical components in life support devices or systems without the expressed written approval of the President of Diodes Incorporated.